

Low Voltage Alternators - 4 pole

LSA 52.3

1860 to 2500 kVA - 50 Hz / 2230 to 3000 kVA - 60 Hz
Electrical and mechanical data

Leroy-Somer™

EMERSON™

Low Voltage Alternators - 4 pole

LSA 52.3 - 1860 to 2500 kVA - 50 Hz / 2230 to 3000 kVA - 60 Hz

Specially adapted to applications

The LSA 52.3 alternator is designed to be suitable for typical generator applications, such as: backup, marine applications, rental, telecommunications, etc.

Compliant with international standards

The LSA 52.3 alternator conforms to the main international standards and regulations:

- IEC 60034, NEMA MG 1.32-33, ISO 8528-3, CSA C22.2 n°100-14, UL 1446 (UL 1004 on request), marine regulations, etc.

It can be integrated into a CE marked generator.

The LSA 52.3 is designed, manufactured and marketed in an ISO 9001 and ISO 14001 environment.

Top of the range electrical performance

- Class H insulation.
- Standard 6-wire winding, 2/3 pitch, type no. 6S.
- Voltage range 50 Hz: 380V - 400V - 415V - 440 V.
- Voltage range 60 Hz: 380V - 416V - 440V - 480V.
- High efficiency and motor starting capacity.
- Other voltages are possible with optional adapted windings:
 - 50 Hz : 440 V (no. 7S), 500 V (no. 9S), 600 V (no. 22S or 23S), 690 V (no. 10S or 52S).
 - 60 Hz : 380 V and 416 V (no. 8S), 600 V (no. 9S).
- R 791 interference suppression conforming to standard EN 61000-6-3, EN 61000-6-2, EN 55011 group 1 class B standard for European zone (CE marking).

Excitation and regulation system suited to the application

The LSA 52.3 can be supplied with AREP + PMI or PMG excitation system, according to the alternator specification.

Standard excitation system is AREP with D 510C A.V.R.

Excitation system			Regulation options				
Volage regulator	AREP + PMI	PMG	Current transformer for paralleling	Mains paralleling	3-phase sensing	3-phase sensing for mains paralleling unbalanced	Remote voltage potentiometer
D510C	Std	Option	C.T.	included	included	contact factory	Option
R449	Option	Option	C.T.	R 726	R731	R734	Option

Protection system suited to the environment

- The LSA 52.3 is IP 23.
- Standard winding protection for clean environments with relative humidity $\leq 95\%$, including indoor marine environments.
- Options :
 - Filters on air inlet : derating 5%.
 - Filters on air inlet and air outlet (IP 44) : derating 8%.
 - Winding protections for harsh environments and relative humidity greater than 95%.
 - Space heaters.
 - Protection or metering CTs.
 - Thermal protection for stator windings &/or bearings (PT100).

Reinforced mechanical structure using finite element modelling

- Compact and rigid assembly to better withstand generator vibrations.
- Steel frame.
- Cast iron flanges and shields.
- Twin-bearing and single-bearing versions designed to be suitable for engines on the market.
- Half-key balancing.
- Regreasable bearings.
- Clockwise rotation in standard.

Accessible terminal box proportioned for optional equipment

- Easy access to the voltage regulator and to the connections.
- Possible inclusion of accessories for paralleling, protection and measurement.

Low Voltage Alternators - 4 pole

LSA 52.3 - 1860 to 2500 kVA - 50 Hz / 2230 to 3000 kVA - 60 Hz

General characteristics

Insulation class	H	Excitation system	AREP + PMI
Winding pitch	2/3 (n° 6S)	AVR type	D 510C
Number of wires	6	Voltage regulation (*)	± 0.5 %
Protection	IP 23	Short-circuit current	300% (3 IN) : 10s
Altitude	≤ 1000 m	Totale Harmonic distortion THD (**)	< 4 %
Overspeed	2250 min ⁻¹	Waveform: NEMA = TIF (**)	< 50
Air flow	2.5 m ³ /s (50 Hz) - 2.8 m ³ /s (60 Hz)	Waveform: I.E.C. = THF (**)	< 2 %

(*) steady state (**) between phases

Ratings 50 Hz - 1500 R.P.M.

kVA / kW - P.F. = 0.8																	
Duty/T°C		Continuous duty/40°C				Continuous duty/40°C				Stand-by/40°C				Stand-by/27°C			
Class/T°K		H/125°K				F/105°K				H/150°K				H/163°K			
Phase		3 ph.				3 ph.				3 ph.				3 ph.			
Y		380V	400V	415V	440V	380V	400V	415V	440V	380V	400V	415V	440V	380V	400V	415V	440V
LSA 52.3 S5	kVA	1860		1691		1696		1542		1972		1793		2046		1860	
	kW	1488		1353		1357		1234		1578		1434		1637		1488	
LSA 52.3 S6	kVA	2000		1818		1824		1658		2120		1927		2200		2000	
	kW	1600		1454		1459		1326		1696		1542		1760		1600	
LSA 52.3 S7	kVA	2200		2000		2006		1824		2332		2120		2420		2200	
	kW	1760		1600		1605		1459		1866		1696		1936		1760	
LSA 52.3 L9	kVA	2360		2145		2152		1956		2502		2275		2596		2360	
	kW	1888		1716		1722		1565		2002		1820		2077		1888	
LSA 52.3 L12	kVA	2500		2273		2280		2073		2650		2409		2750		2500	
	kW	2000		1818		1824		1658		2120		1927		2200		2000	

Ratings 60 Hz - 1800 R.P.M.

kVA / kW - P.F. = 0.8																	
Duty/T°C		Continuous duty/40°C				Continuous duty/40°C				Stand-by/40°C				Stand-by/27°C			
Class/T°K		H/125°K				F/105°K				H/150°K				H/163°K			
Phase		3 ph.				3 ph.				3 ph.				3 ph.			
Y		380V	416V	440V	480V	380V	416V	440V	480V	380V	416V	440V	480V	380V	416V	440V	480V
LSA 52.3 S5	kVA	1860	1934	2046	2232	1697	1765	1866	2036	1972	2051	2169	2366	2046	2128	2250	2455
	kW	1488	1547	1637	1786	1358	1412	1493	1629	1578	1641	1735	1893	1637	1702	1800	1964
LSA 52.3 S6	kVA	2000	2080	2200	2400	1824	1897	2007	2189	2120	2205	2332	2544	2200	2288	2420	2640
	kW	1600	1664	1760	1920	1459	1518	1606	1751	1696	1764	1866	2035	1760	1830	1936	2112
LSA 52.3 S7	kVA	2200	2288	2420	2640	2007	2087	2207	2408	2332	2425	2565	2798	2420	2517	2662	2904
	kW	1760	1830	1936	2112	1606	1670	1766	1926	1866	1940	2052	2238	1936	2014	2130	2323
LSA 52.3 L9	kVA	2360	2454	2596	2832	2153	2239	2368	2583	2502	2602	2752	3002	2596	2700	2855	3115
	kW	1888	1963	2077	2266	1722	1791	1894	2066	2002	2082	2202	2402	2077	2160	2284	2492
LSA 52.3 L12	kVA	2500	2600	2750	3000	2280	2371	2508	2736	2650	2756	2915	3180	2750	2860	3025	3300
	kW	2000	2080	2200	2400	1824	1897	2006	2189	2120	2205	2332	2544	2200	2288	2420	2640

Low Voltage Alternators - 4 pole

LSA 52.3 - 1860 to 2500 kVA - 50 Hz / 2230 to 3000 kVA - 60 Hz

Efficiencies 400V - 50 Hz (— P.F.: 1) (----- P.F.: 0.8)

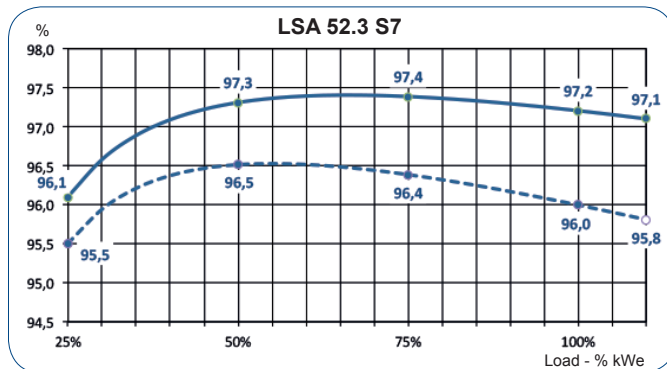
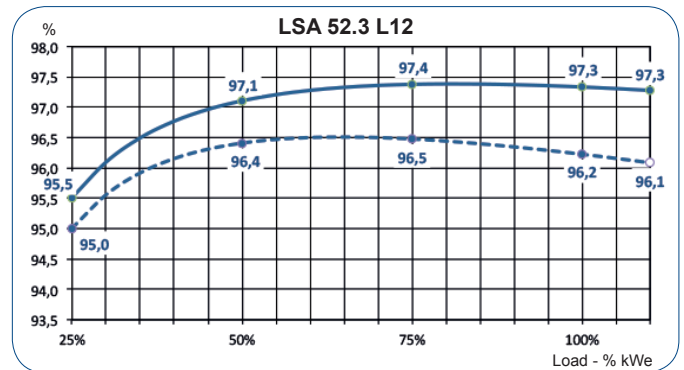
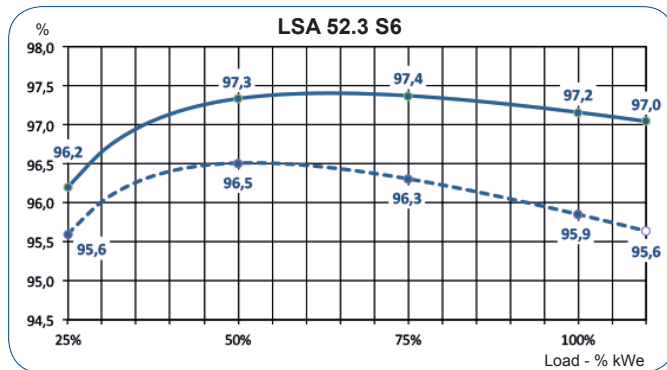
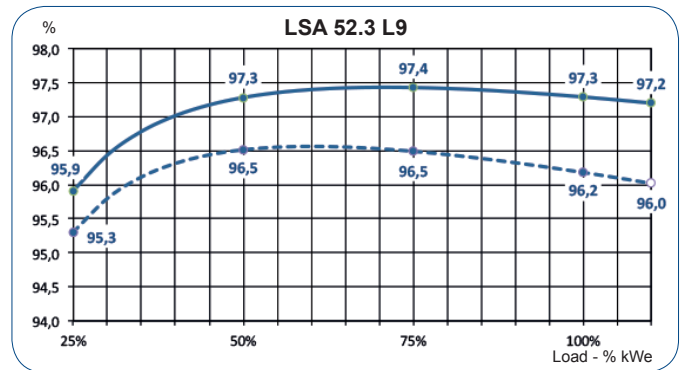
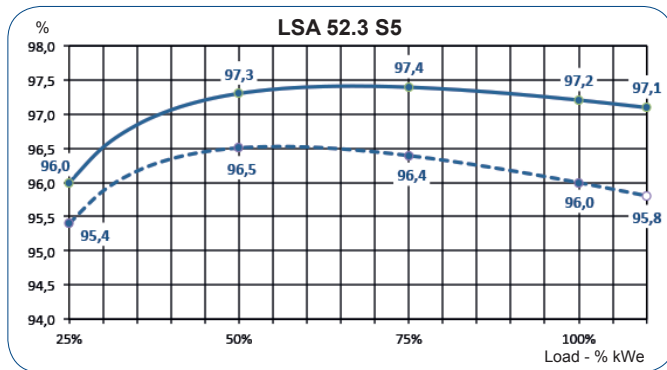

Reactances (%). Time constants (ms) - Class H / 400 V

	S5	S6	S7	L9	L12
Kcc Short-circuit ratio	0.35	0.32	0.35	0.39	0.43
Xd Direct-axis synchronous reactance unsaturated	367	380	376	344	306
Xq Quadrature-axis synchronous reactance unsaturated	187	194	192	175	156
T'do No-load transient time constant	2760	2760	2870	2990	3150
X'd Direct-axis transient reactance saturated	28.7	30.9	28.9	26.1	23
T'd Short-circuit transient time constant	254	264	260	267	279
X''d Direct-axis subtransient reactance saturated	15	16.4	14.8	13.2	11.5
T''d Subtransient time constant	23	23	22	22	22
X''q Quadrature-axis subtransient reactance saturated	15.6	16.9	15.4	13.7	12
X0 Zero sequence reactance unsaturated	2.3	2.5	2.6	2.5	2.7
X2 Negative sequence reactance saturated	15.3	16.7	15.1	13.4	11.7
Ta Armature time constant	28	28	28	28	28

Other class H/400 V data

io (A) No-load excitation current	1.1	1.1	1.2	1.2	1.2
ic (A) On-load excitation current	4.8	5.1	5	4.7	4.3
uc (V) On-load excitation voltage	55	58	57	53	49
kW No-load losses	18	18	20	23	25
kW Heat dissipation	66	74	78	80	82

Low Voltage Alternators - 4 pole

LSA 52.3 - 1860 to 2500 kVA - 50 Hz / 2230 to 3000 kVA - 60 Hz

Transient voltage variation at load inrush: 400V - 50 Hz

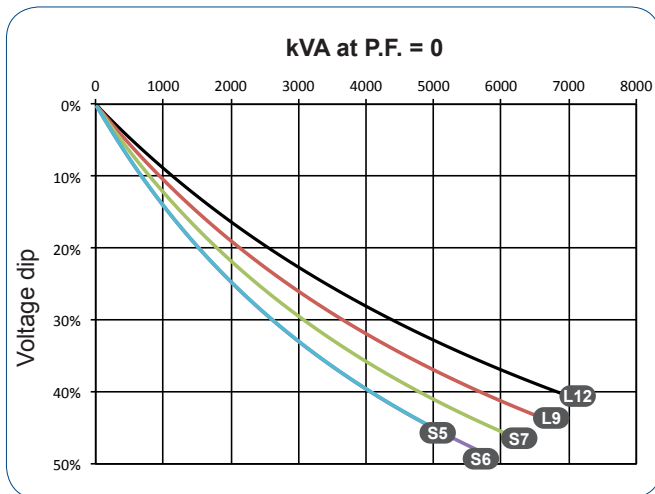
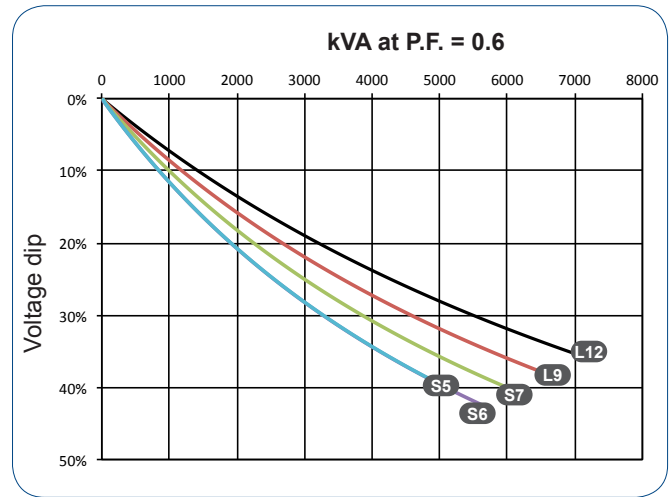
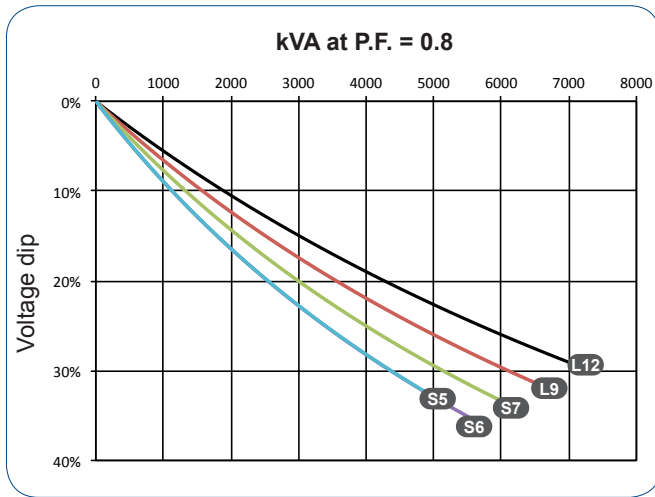

Transient voltage variation at load rejection: 400V - 50 Hz

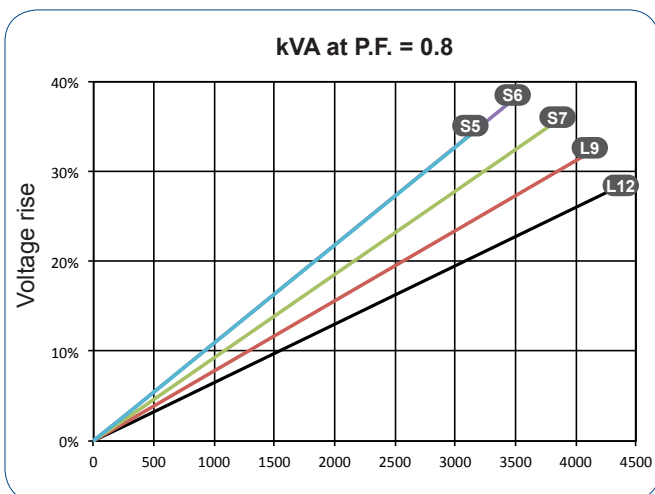

Low Voltage Alternators - 4 pole

LSA 52.3 - 1860 to 2500 kVA - 50 Hz / 2230 to 3000 kVA - 60 Hz

Efficiencies 480V - 60 Hz (— P.F.: 1) (----- P.F.: 0.8)

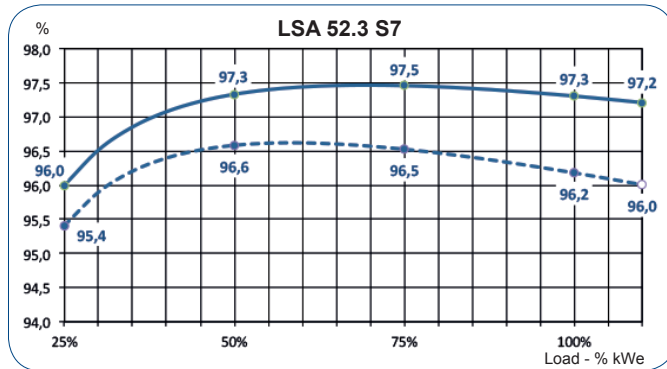
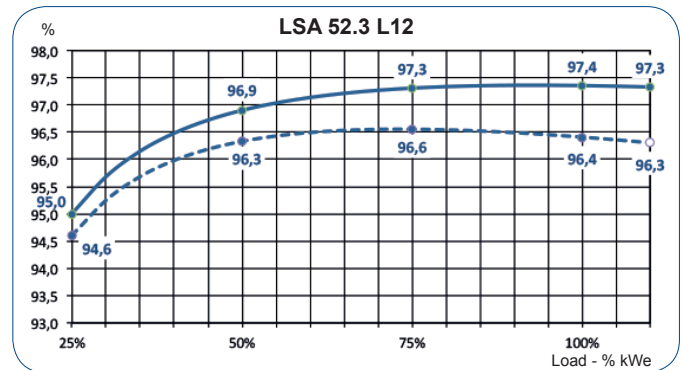
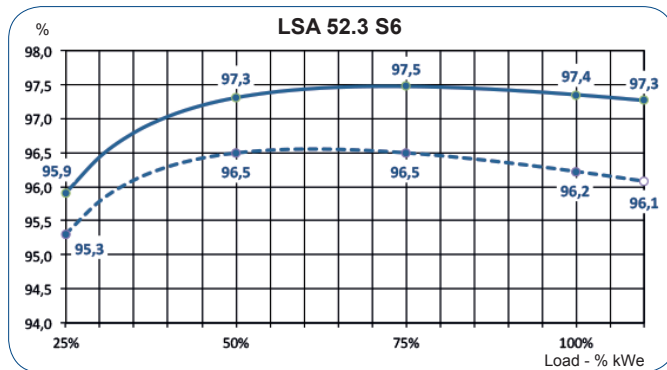
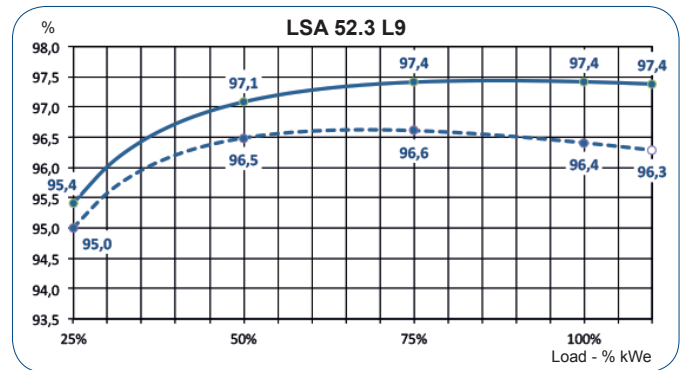
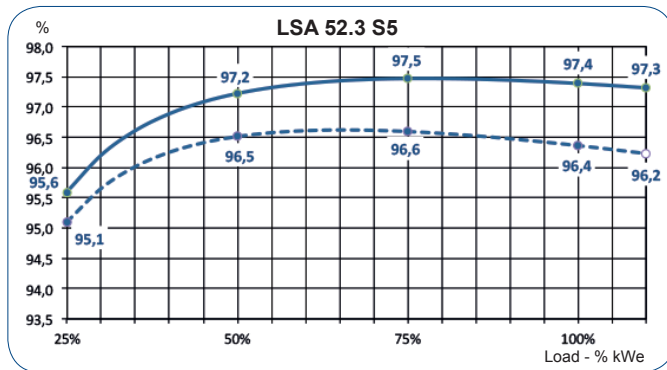

Reactances (%). Time constants (ms) - Class H / 480 V

	S5	S6	S7	L9	L12
Kcc Short-circuit ratio	0.35	0.32	0.35	0.39	0.43
Xd Direct-axis synchronous reactance unsaturated	367	380	376	344	306
Xq Quadrature-axis synchronous reactance unsaturated	187	194	192	175	156
T'do No-load transient time constant	2760	2760	2870	2990	3150
X'd Direct-axis transient reactance saturated	28.7	30.9	28.9	26.1	23
T'd Short-circuit transient time constant	254	265	260	267	279
X''d Direct-axis subtransient reactance saturated	15	16.4	14.8	13.2	11.5
T''d Subtransient time constant	23	23	22	22	22
X''q Quadrature-axis subtransient reactance saturated	15.6	16.9	15.4	13.7	12
X0 Zero sequence reactance unsaturated	2.3	2.6	2.6	2.5	2.7
X2 Negative sequence reactance saturated	15.3	16.7	15.1	13.4	11.7
Ta Armature time constant	28	28	28	28	28

Other class H/480 V data

	S5	S6	S7	L9	L12
io (A) No-load excitation current	1.1	1.1	1.2	1.2	1.2
ic (A) On-load excitation current	4.6	5.1	4.8	4.6	4.2
uc (V) On-load excitation voltage		58	54	52	48
kW No-load losses	24	24	27	31	36
kW Heat dissipation	66	82	85	87	92

Low Voltage Alternators - 4 pole

LSA 52.3 - 1860 to 2500 kVA - 50 Hz / 2230 to 3000 kVA - 60 Hz

Transient voltage variation at load inrush: 480V - 60 Hz

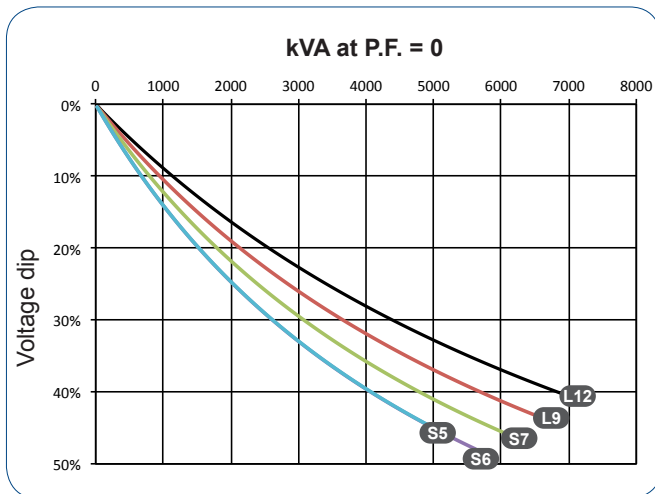
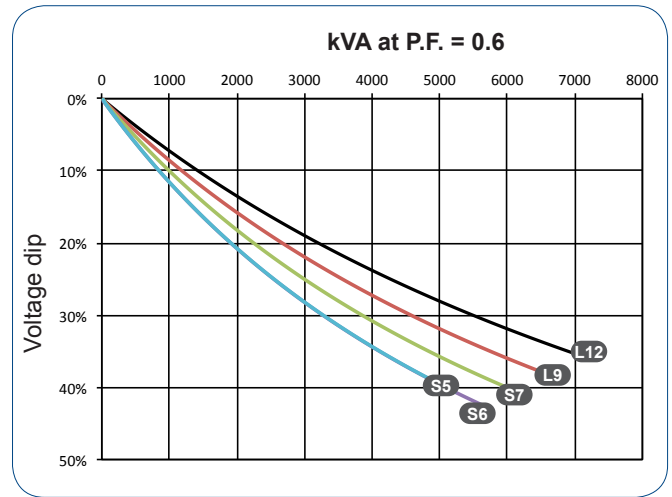
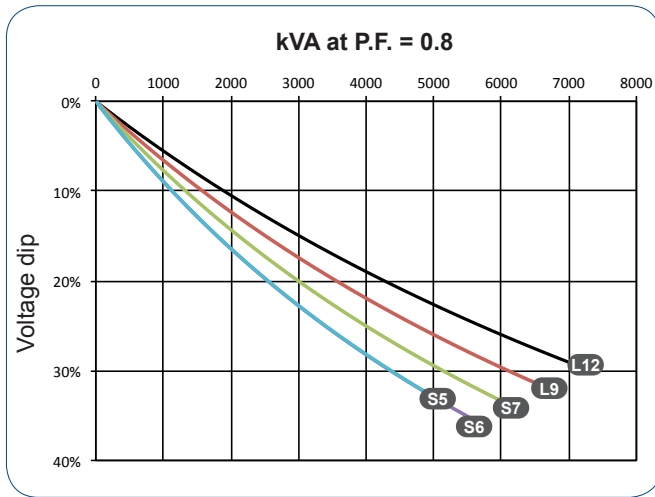

Transient voltage variation at load rejection: 480V - 60 Hz

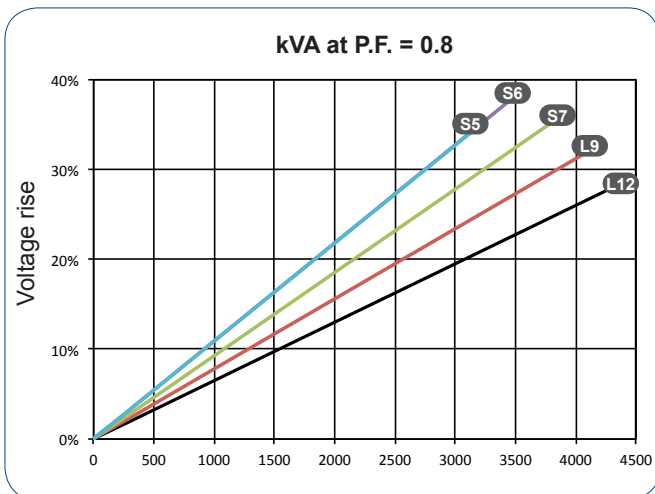

Low Voltage Alternators - 4 pole

LSA 52.3 - 1860 to 2500 kVA - 50 Hz / 2230 to 3000 kVA - 60 Hz

Short-circuit curves

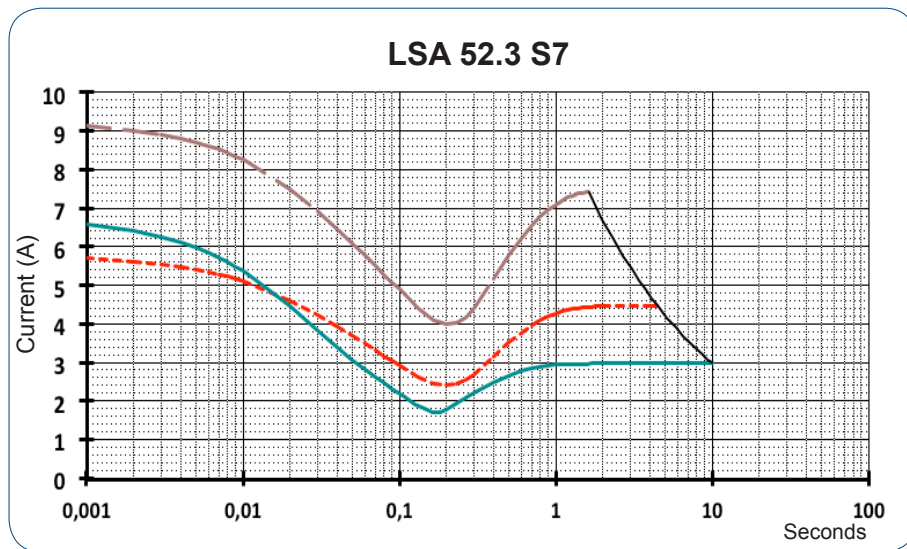
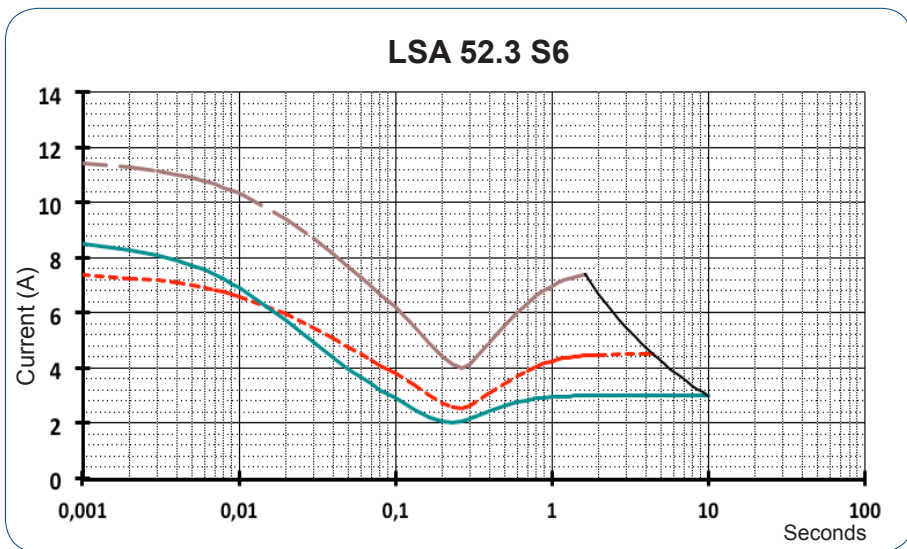
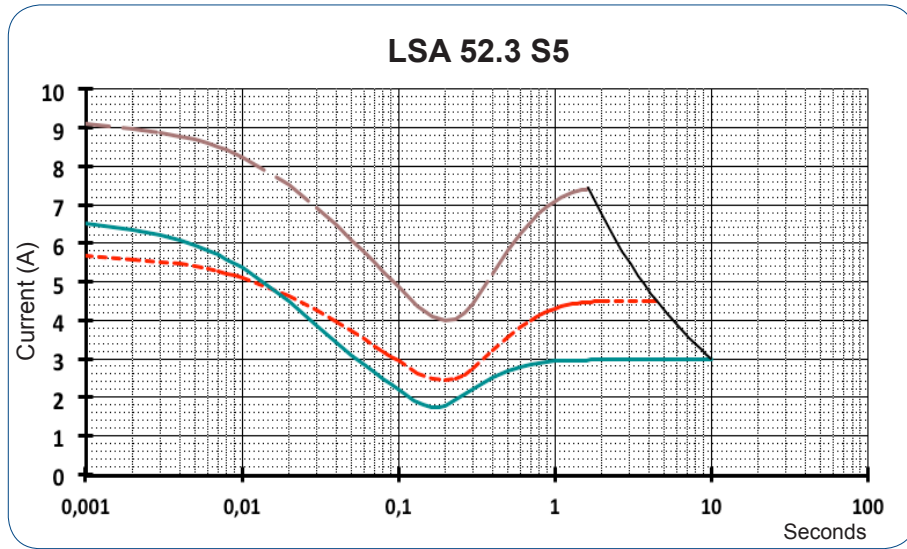

Low Voltage Alternators - 4 pole

LSA 52.3 - 1860 to 2500 kVA - 50 Hz / 2230 to 3000 kVA - 60 Hz

Short-circuit curves

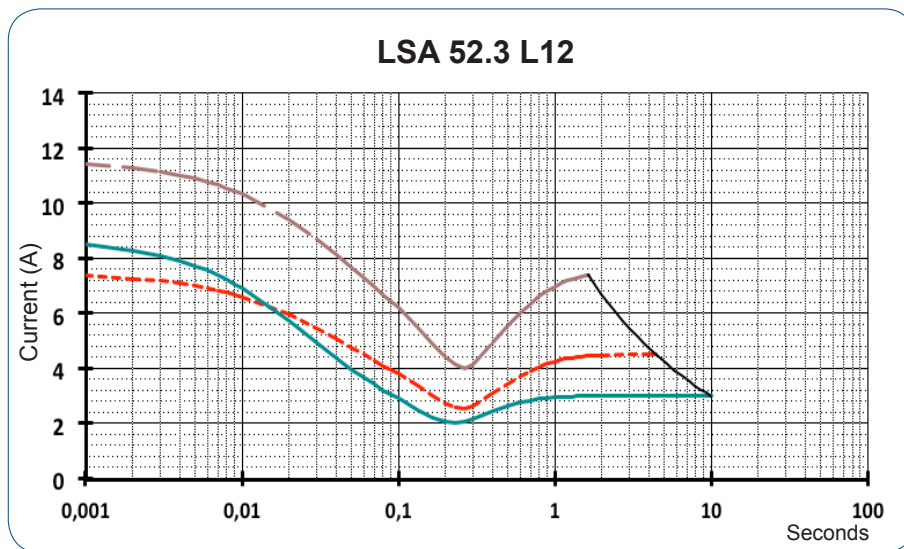
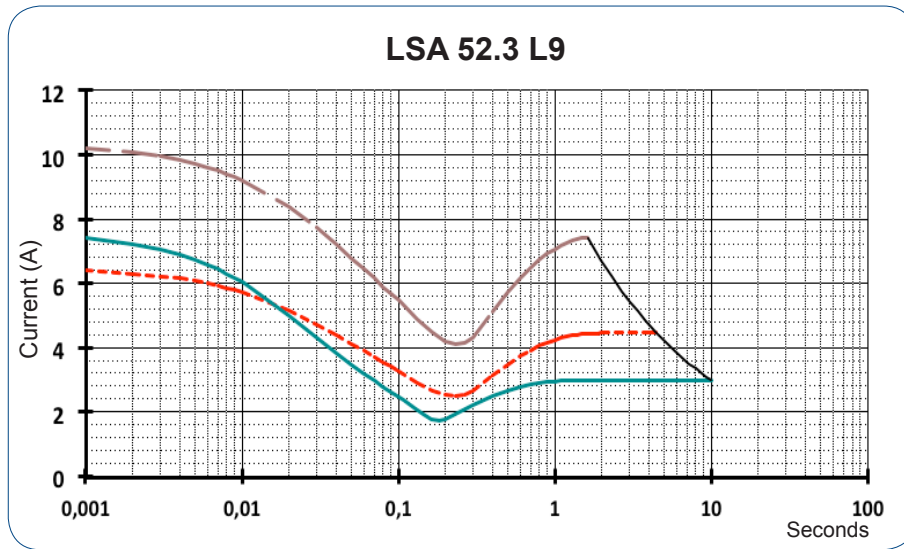

- Symmetrical phase to neutral short circuit
- - - Symmetrical two phase short circuit
- Symmetrical three phase short circuit
- Heat damage curve limit

Low Voltage Alternators - 4 pole

LSA 52.3 - 1860 to 2500 kVA - 50 Hz / 2230 to 3000 kVA - 60 Hz

Single bearing dimensions

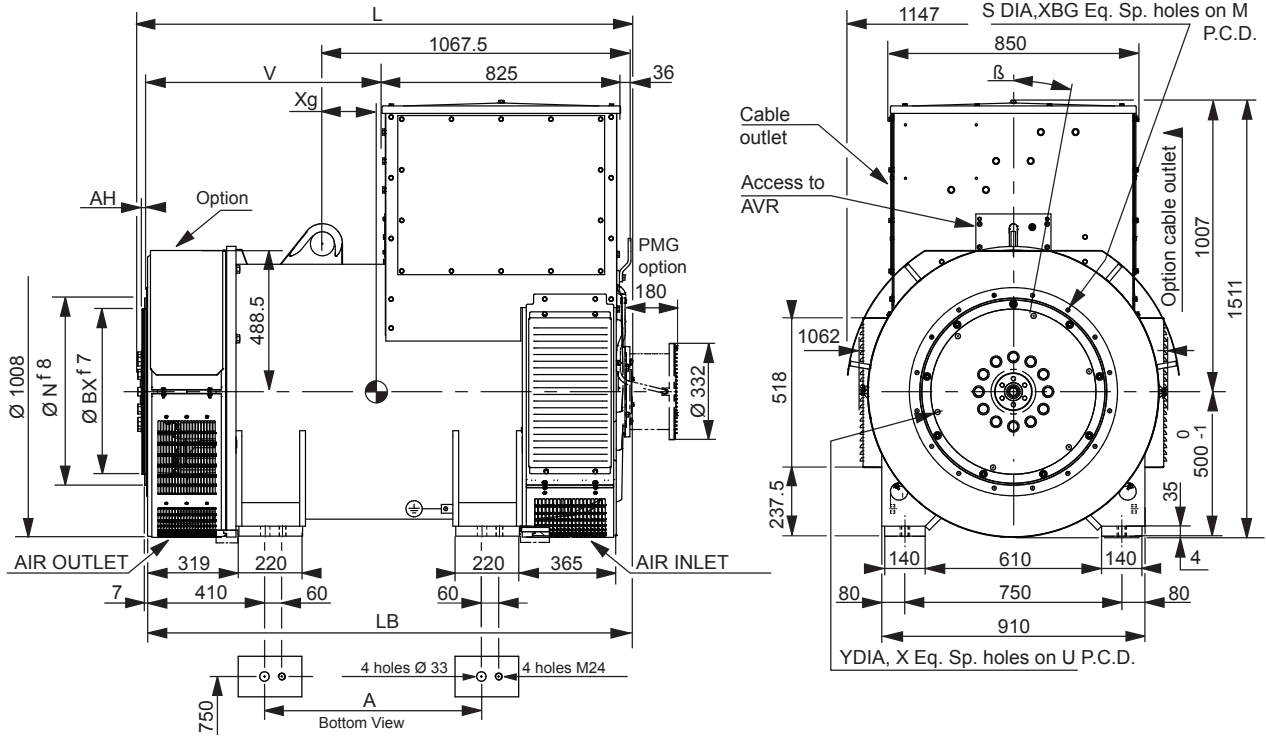

Dimensions (mm) and weight						
Type	L without PMG	LB	A	V	Xg	Weight (*) (kg)
LSA 52.3 S5	1713	1683	750	814	187	3705
LSA 52.3 S6	1713	1683	750	814	187	3705
LSA 52.3 S7	1713	1683	750	814	207	3950
LSA 52.3 L9	1913	1883	950	1014	78	4433
LSA 52.3 L12	1913	1883	950	1014	112	4924

Coupling		
Flange S.A.E.	0	00
Flex plate S.A.E. 21	X	X
Flex plate S.A.E. 18	X	X

(*) values for S.A.E. 00/21

Flange (mm)					
S.A.E.	N	M	XBG	S	β°
0	647.7	679.5	16	14	11° 15'
00	787.4	850.9	16	14	11° 15'

Flex plate (mm)					
S.A.E.	BX	U	X	Y	AH
21	673.1	641.3	12	18	0
18	571.5	542.9	6	18	15.8

Torsional analysis data

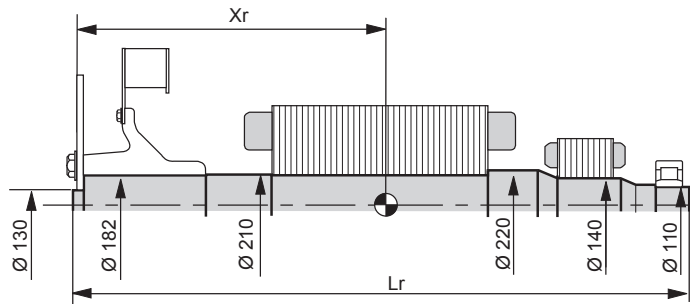
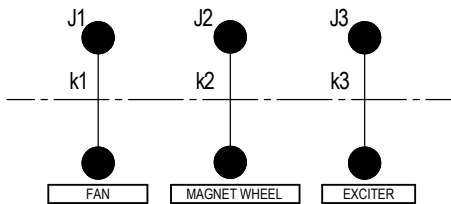

Type	Centre of gravity: Xr (mm), Rotor length: Lr (mm), Weight: M (kg), Moment of inertia: J (kgm ²) : (4J = MD ²)							
	Flex plate S.A.E. 18				Flex plate S.A.E. 21			
	Xr	Lr	M	J	Xr	Lr	M	J
LSA 52.3 S5	720.4	1689	1420	43.4	702.8	1689	1424	44.3
LSA 52.3 S6	720.4	1689	1420	43.4	702.8	1689	1424	44.3
LSA 52.3 S7	741.5	1689	1453	45	723.9	1689	1457	45.9
LSA 52.3 L9	811.3	1889	1635	50	793.7	1889	1639	50.9
LSA 52.3 L12	858.4	1889	1808	56.5	840.9	1889	1812	57.4

Torsional rigidity					
[Nm/rad]			(kg.m ²)		
k1	k2	k3	J1	J2	J3
5.00 10E7	2.50 10E7	1.54 10E7	10.3	32.4	1.5
5.00 10E7	2.50 10E7	1.54 10E7	10.3	32.4	1.5
5.00 10E7	2.41 10E7	1.59 10E7	10.3	34.1	1.5
5.00 10E7	2.29 10E7	1.42 10E7	10.3	39	1.6
5.00 10E7	2.14 10E7	1.52 10E7	10.3	45.6	1.4

NOTE : Dimensions are for information only and may be subject to modifications. Contractuel 2D drawings can be downloaded from the Leroy-Somer site, 3D drawing files are available upon request. The torsional analysis of the transmission is imperative. All values are available upon request.

Low Voltage Alternators - 4 pole

LSA 52.3 - 1860 to 2500 kVA - 50 Hz / 2230 to 3000 kVA - 60 Hz

Two bearing dimensions

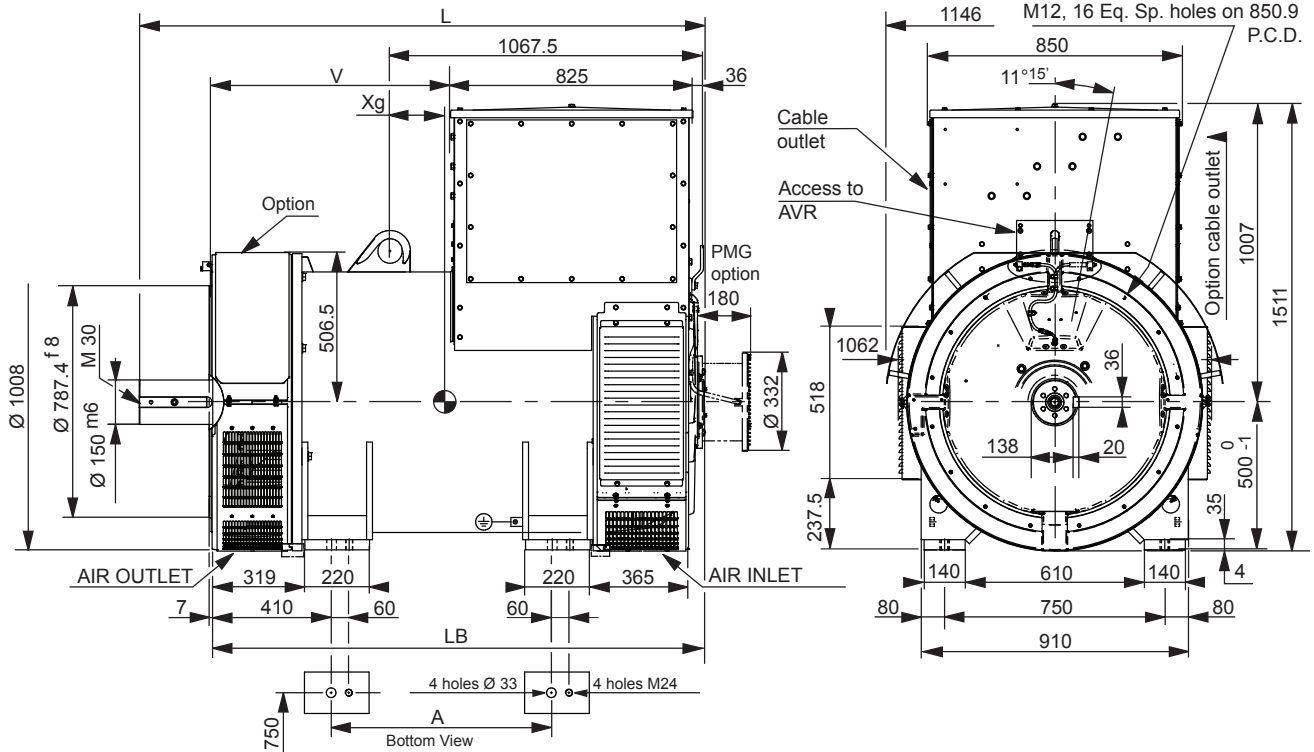

Dimensions (mm) and weight						
Type	L without PMG	LB	A	V	Xg	Weight (kg)
LSA 52.3 S5	1933	1683	750	814	192	3748
LSA 52.3 S6	1933	1683	750	814	192	3748
LSA 52.3 S7	1933	1683	750	814	212	3991
LSA 52.3 L9	2133	1883	950	1014	83	4476
LSA 52.3 L12	2133	1883	950	1014	117	4967

Torsional analysis data

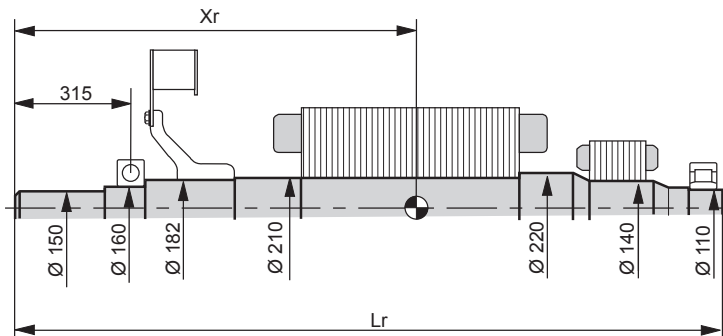
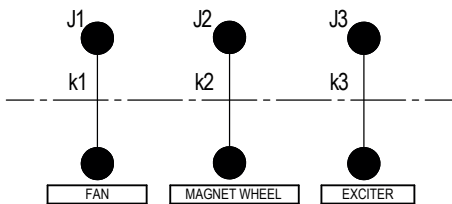

Type	Centre of gravity: Xr (mm), Rotor length: Lr (mm), Weight: M (kg), Moment of inertia: J (kgm ²): (4J = MD ²)				Torsional rigidity					
	Xr	Lr	M	J	[Nm/rad]			(kg.m ²)		
					k1	k2	k3	J1	J2	J3
LSA 52.3 S5	973.4	1912	1363	41.7	1.82 10E7	3.05 10E7	1.54 10E7	7.7	32.4	1.5
LSA 52.3 S6	973.4	1912	1363	41.7	1.82 10E7	3.05 10E7	1.54 10E7	7.7	32.4	1.5
LSA 52.3 S7	994.5	1912	1396	43.3	1.82 10E7	2.91 10E7	1.59 10E7	7.7	34.1	1.5
LSA 52.3 L9	1064.3	2112	1578	48.3	1.82 10E7	2.74 10E7	1.42 10E7	7.7	39	1.6
LSA 52.3 L12	1110.6	2112	1752	54.8	1.82 10E7	2.53 10E7	1.52 10E7	7.7	45.6	1.4

NOTE : Dimensions are for information only and may be subject to modifications. Contractuel 2D drawings can be downloaded from the Leroy-Somer site. 3D drawing files are available upon request. The torsional analysis of the transmission is imperative. All values are available upon request.

EMERSON. CONSIDER IT SOLVED.™

www.emerson.com/epg

© Emerson 2014. The information contained in this brochure is for guidance only and does not form part of any contract. The accuracy cannot be guaranteed as Emerson have an ongoing process of development and reserve the right to change the specification of their products without notice.

Moteurs Leroy-Somer SAS. Headquarters: Bd Marcellin Leroy, CS 10015, 16915 Angoulême Cedex 9, France. Share Capital: 65 800 512 €, RCS Angoulême 338 567 258.

Leroy-Somer™

