

name=  
urlparam  
pos=724  
11  
11

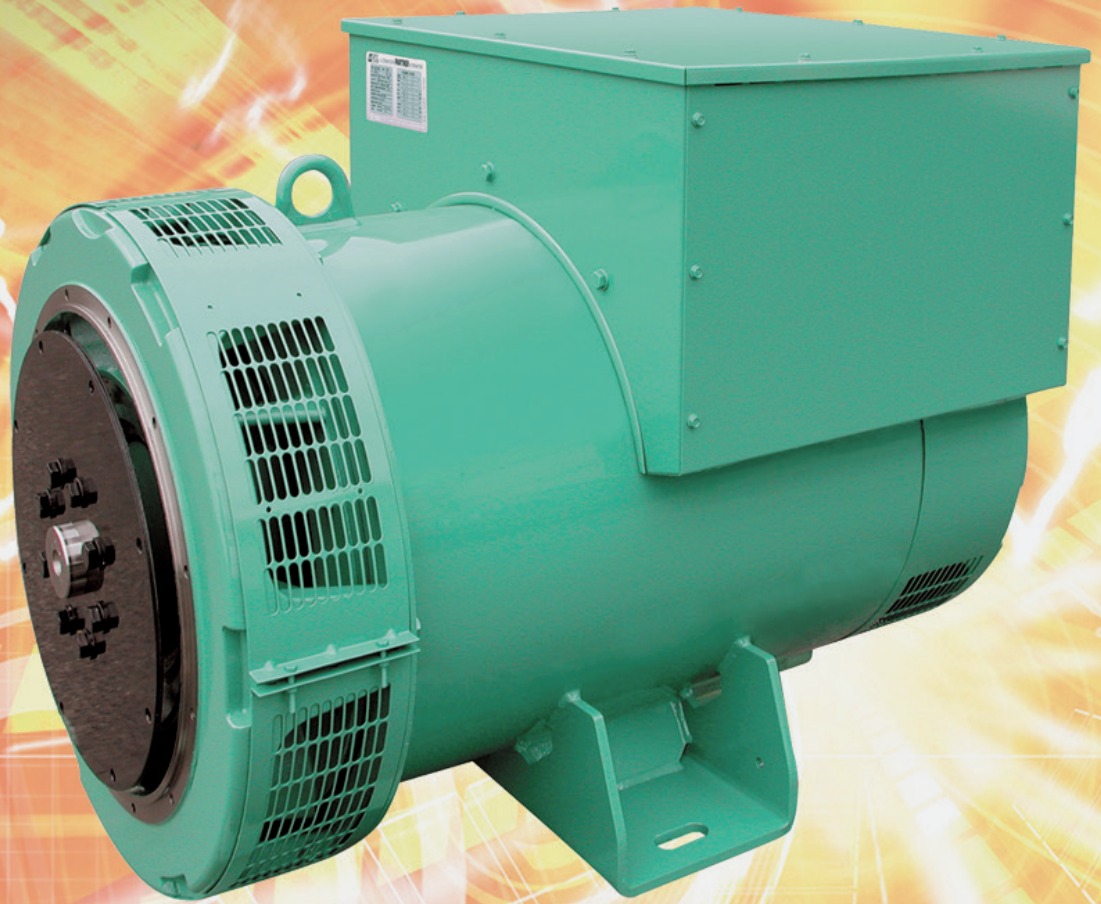

## Low Voltage Alternators - 4 pole

**LSA 47.2**

365 to 600 kVA - 50 Hz / 456 to 750 kVA - 60 Hz  
Electrical and mechanical data

**Leroy-Somer™**

  
**EMERSON™**  
Industrial Automation

# Low Voltage Alternators - 4 pole

## LSA 47.2 - 365 to 600 kVA - 50 Hz / 456 to 750 kVA - 60 Hz

### Specially adapted to applications

The LSA 47.2 alternator is designed to be suitable for typical generator applications, such as: backup, marine applications, rental, telecommunications, etc.

### Compliant with international standards

The LSA 47.2 alternator conforms to the main international standards and regulations:

- IEC 60034, NEMA MG 1.32-33, ISO 8528-3, CSA/ UL 1446 (UL 1004 on request), marine regulations, etc.

It can be integrated into a CE marked generator.

The LSA 47.2 is designed, manufactured and marketed in an ISO 9001 and ISO 14001 environment.

### Top of the range electrical performance

- Class H insulation.
- Standard 12-wire re-connectable winding, 2/3 pitch, type no. 6 (the LSA 47.2 L9 is available in two versions: 6-wire and 12-wire).
- Voltage range 50 Hz: 220 V - 240 V and 380 V - 415 V (440 V).
- Voltage range 60 Hz: 208 V - 240 V and 380 V - 480 V.
- High efficiency and motor starting capacity.
- Other voltages are possible with optional adapted windings:
  - 50 Hz : 440 V (no. 7), 500 V (no. 9), 600 V (no. 23), 690 V (no. 52).
  - 60 Hz : 380 V and 416 V (no. 8), 600 V (no. 9).
- R 791 interference suppression conforming to standard EN 55011 group 1 class B standard for European zone (CE marking).

### Excitation and regulation system suited to the application

Excitation system				Regulation options				
Volage regulator	SHUNT	AREP	PMG	Current transformer for paralleling	Mains paralleling	3-phase sensing	3-phase sensing for mains paralleling unbalanced	Remote voltage potentiometer
R250	Std	-	-	-	-	-	-	√
R450	Option	Std	Std	C.T.	R726	R731	R734	√
D510C	Option	Option	Option	C.T.	included	included	included	√

√ : possible mounting

### Protection system suited to the environment

- The LSA 47.2 is IP 23.
- Standard winding protection for clean environments with relative humidity  $\leq 95\%$ , including indoor marine environments.
  - Options :
    - Filters on air inlet : derating 5%.
    - Filters on air inlet and air outlet (IP 44) : derating 10%.
    - Winding protections for harsh environments and relative humidity greater than 95%.
    - Space heaters.
    - Thermal protection for windings and shields.

### Reinforced mechanical structure using finite element modelling

- Compact and rigid assembly to better withstand generator vibrations.
- Steel frame.
- Cast iron flanges and shields.
- Twin-bearing and single-bearing versions designed to be suitable for engines on the market.
- Half-key balancing.
- Sealed for life ball bearings, regreasable bearings (optional).
- Standard direction of rotation : clockwise when looking at the drive end view (for anti-clockwise, derate the machine by 5%).

### Accessible terminal box proportioned for optional equipment

- Easy access to the voltage regulator and to the connections.
- Possible inclusion of accessories for paralleling, protection and measurement.
- 9-way terminal block for voltage reconnection.

# Low Voltage Alternators - 4 pole

## LSA 47.2 - 365 to 600 kVA - 50 Hz / 456 to 750 kVA - 60 Hz

### General characteristics

Insulation class	H	Excitation system	SHUNT (12 wire)	AREP or PMG
Winding pitch	2/3 (N° 6 or N° 6S)	AVR type	R 250	R 450
Number of wires	12 (N° 6) / 6 (N° 6S)	Voltage regulation (*)	± 0.5 %	± 0.5 %
Protection	IP 23	Short-circuit current	-	300% (3 IN) : 10s
Altitude	≤ 1000 m	Totale Harmonic distortion THD (**)	no load < 1.5% - on load < 2%	
Overspeed	2250 min <sup>-1</sup>	Waveform: NEMA = TIF (**)	< 50	
Air flow	0.9 m <sup>3</sup> /s (50Hz) / 1.1 (60Hz)			

(\*) Steady state. (\*\*) Total harmonic distortion between phases, no-load or on-load (non-distorting)

### Ratings 50 Hz - 1500 R.P.M.

kVA / kW - P.F. = 0.8															
Duty/T°C	Continuous duty/40°C				Continuous duty/40°C				Stand-by/40°C			Stand-by/27°C			
Class/T°K	H/125°K				F/105°K				H/150°K			H/163°K			
Phase	3 ph.				3 ph.				3 ph.			3 ph.			
Y	380V	400V	415V		380V	400V	415V		380V	400V	415V	380V	400V	415V	
Δ	220V	230V	240V		220V	230V	240V		220V	230V	240V	220V	230V	240V	
YY		200V				200V				200V			200V		
<b>12 wires version</b>															
<b>LSA 47.2 VS2</b>	kVA	<b>365</b>				330				405			<b>420</b>		
	kW	<b>292</b>				264				324			<b>336</b>		
<b>LSA 47.2 S4</b>	kVA	<b>410</b>				370				430			<b>450</b>		
	kW	<b>328</b>				296				344			<b>360</b>		
<b>LSA 47.2 S5</b>	kVA	<b>455</b>				405				471			<b>500</b>		
	kW	<b>364</b>				324				377			<b>400</b>		
<b>LSA 47.2 M7</b>	kVA	<b>500</b>				465				550			<b>570</b>		
	kW	<b>400</b>				372				440			<b>456</b>		
<b>LSA 47.2 M8</b>	kVA	<b>550</b>				500				575			<b>600</b>		
	kW	<b>440</b>				400				460			<b>480</b>		
<b>LSA 47.2 L9</b>	kVA	<b>600</b>				535				630			<b>660</b>		
	kW	<b>480</b>				428				504			<b>528</b>		
<b>6 wires version</b>															
Y	380V	400V	415V		380V	400V	415V		380V	400V	415V	380V	400V	415V	
Δ	220V	230V	240V		220V	230V	240V		220V	230V	240V	220V	230V	240V	
<b>LSA 47.9 L9*</b>	kVA	<b>600</b>				535				630			<b>660</b>		
	kW	<b>480</b>				428				504			<b>528</b>		

### Ratings 60 Hz - 1800 R.P.M.

kVA / kW - P.F. = 0.8																	
Duty/T°C	Continuous duty/40°C				Continuous duty/40°C				Stand-by/40°C				Stand-by/27°C				
Class/T°K	H/125°K				F/105°K				H/150°K				H/163°K				
Phase	3 ph.				3 ph.				3 ph.				3 ph.				
Y	380V	416V	440V	480V	380V	416V	440V	480V	380V	416V	440V	480V	380V	416V	440V	480V	
Δ	220V	240V			220V	240V			220V	240V			220V	240V			
YY		208V	220V	240V		208V	220V	240V		208V	220V	240V		208V	220V	240V	
<b>12 wires version</b>																	
<b>LSA 47.2 VS2</b>	kVA	424	454	456	<b>456</b>	394	410	410	410	451	483	500	511	469	500	518	<b>530</b>
	kW	339	363	365	<b>365</b>	315	328	328	328	361	386	400	409	375	400	414	<b>424</b>
<b>LSA 47.2 S4</b>	kVA	450	480	500	<b>512</b>	396	442	442	465	475	513	533	550	500	530	550	<b>581</b>
	kW	360	384	400	<b>410</b>	317	354	354	372	380	410	426	440	400	424	440	<b>465</b>
<b>LSA 47.2 S5</b>	kVA	475	510	531	<b>570</b>	441	473	493	518	503	543	566	592	527	562	585	<b>625</b>
	kW	380	408	425	<b>456</b>	353	378	394	414	402	434	453	474	422	450	468	<b>500</b>
<b>LSA 47.2 M7</b>	kVA	562	610	625	<b>625</b>	523	566	581	590	600	651	669	680	625	668	690	<b>700</b>
	kW	450	488	500	<b>500</b>	418	453	465	472	480	521	535	554	500	534	552	<b>560</b>
<b>LSA 47.2 M8</b>	kVA	562	610	630	<b>690</b>	523	566	587	632	600	651	672	729	625	671	705	<b>750</b>
	kW	450	488	504	<b>552</b>	418	453	470	506	480	521	538	583	500	537	564	<b>600</b>
<b>LSA 47.2 L9</b>	kVA	602	661	685	<b>750</b>	556	609	634	675	643	707	734	780	667	728	763	<b>825</b>
	kW	482	529	548	<b>600</b>	445	487	507	540	514	566	587	624	534	582	610	<b>660</b>
<b>6 wires version</b>																	
Y	380V	416V	440V	480V	380V	416V	440V	480V	380V	416V	440V	480V	380V	416V	440V	480V	
Δ	220V	240V			220V	240V			220V	240V			220V	240V			
<b>LSA 47.2 L9*</b>	kVA	602	661	685	<b>750</b>	556	609	634	675	643	707	734	780	667	728	763	<b>825</b>
	kW	482	529	548	<b>600</b>	445	487	507	540	514	566	587	624	534	582	610	<b>660</b>

\* AREP excitation only

# Low Voltage Alternators - 4 pole

## LSA 47.2 - 365 to 600 kVA - 50 Hz / 456 to 750 kVA - 60 Hz

### Efficiencies 400 V - 50 Hz (P.F.: 1) (P.F.: 0.8)

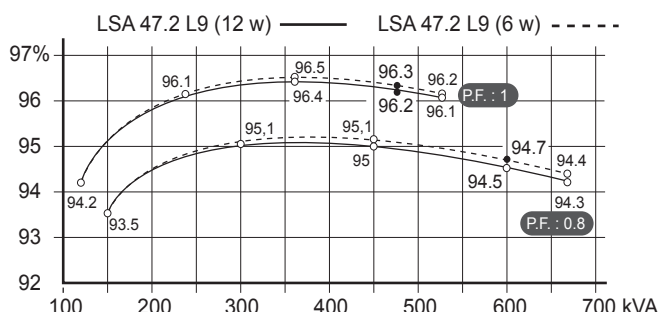
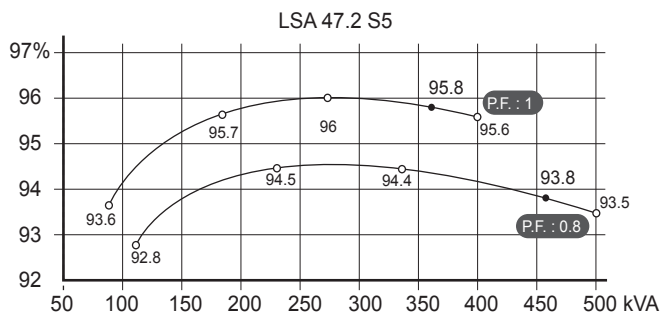
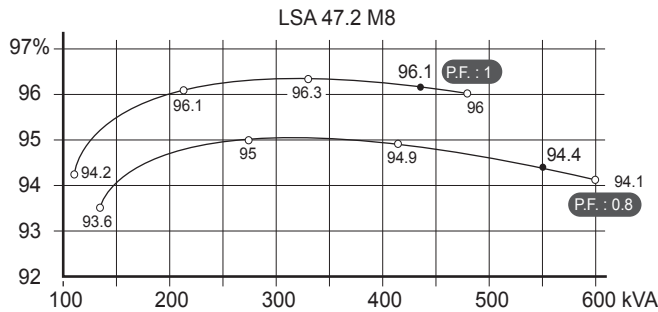
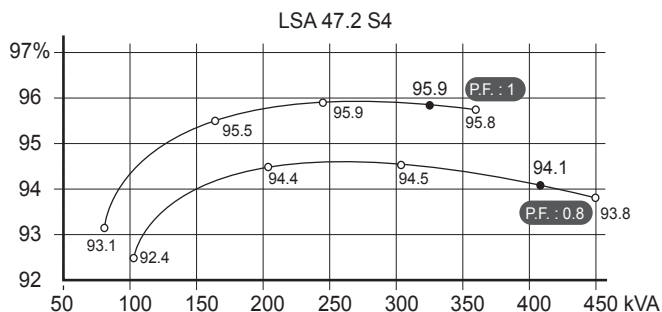
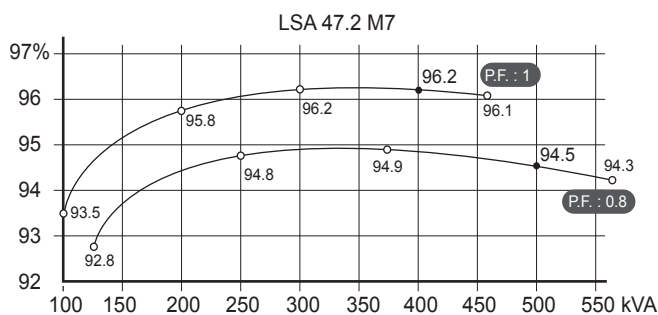
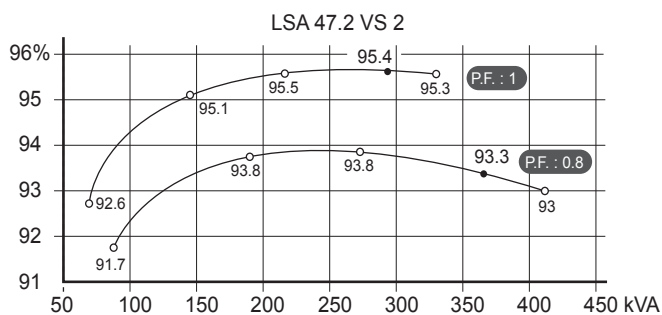

### Reactances (%). Time constants (ms) - Class H / 400 V

		VS2 (12w)	S4 (12w)	S5 (12w)	M7 (12w)	M8 (12w)	L9 (12w)	L9 (6w)
<b>Kcc</b>	Short-circuit ratio	0.38	0.37	0.33	0.41	0.32	0.37	0.38
<b>Xd</b>	Direct-axis synchro. reactance unsaturated	336	322	357	307	360	330	325
<b>Xq</b>	Quadrature-axis synchro. reactance unsaturated	201	193	214	184	216	198	195
<b>T'do</b>	No-load transient time constant	1738	1855	1855	1930	1958	1997	1997
<b>X'd</b>	Direct-axis transient reactance saturated	19.3	17.3	19.2	15.9	18.3	16.5	16.2
<b>T'd</b>	Short-circuit transient time constant	100	100	100	100	100	100	100
<b>X''d</b>	Direct-axis subtransient reactance saturated	13.5	12.1	13.5	11.1	12.9	11.4	11.6
<b>T''d</b>	Subtransient time constant	10	10	10	10	10	10	10
<b>X''q</b>	Quadrature-axis subtransient reactance saturated	18.4	16.3	18	14.7	17	15	15.2
<b>Xo</b>	Zero sequence reactance unsaturated	0.9	0.9	0.9	0.7	0.6	0.9	0.2
<b>X2</b>	Negative sequence reactance saturated	16	14.2	15.8	13	15	13.2	13.4
<b>Ta</b>	Armature time constant	15	15	15	15	15	15	15

### Other class H/400 V data

<b>io (A)</b>	No-load excitation current	1	0.9	0.9	1	0.9	0.9	0.9
<b>ic (A)</b>	On-load excitation current	3.8	3.5	3.8	3.6	3.7	3.7	3.7
<b>uc (V)</b>	On-load excitation voltage	39	35	38	36	37	36	36
<b>ms</b>	Response time ( $\Delta U = 20\%$ transient)	500	500	500	500	500	500	500
<b>kVA</b>	Start ( $\Delta U = 20\%$ cont. or 50% trans.) SHUNT	722	928	928	1073	1159	1258	1258
<b>kVA</b>	Start ( $\Delta U = 20\%$ cont. or 50% trans.) AREP	805	1035	1035	1195	1294	1400	1400
<b>%</b>	Transient $\Delta U$ (on-load 4/4) SHUNT - P.F.: 0.8 <sub>LAG</sub>	16.8	15.5	16.7	14.6	16.2	15	14.8
<b>%</b>	Transient $\Delta U$ (on-load 4/4) AREP - P.F.: 0.8 <sub>LAG</sub>	13.7	12.7	13.6	11.9	13.2	12.2	12.1
<b>W</b>	No-load losses	5440	5690	5690	6540	6120	6780	6880
<b>W</b>	Heat dissipation	20780	20470	23780	23040	26020	27490	26720



# Low Voltage Alternators - 4 pole

LSA 47.2 - 365 to 600 kVA - 50 Hz / 456 to 750 kVA - 60 Hz

## Transient voltage variation 400V - 50 Hz

Load application (SHUNT excitation)

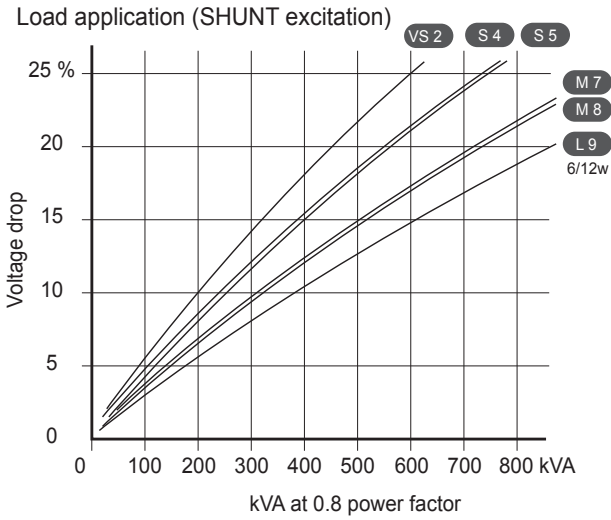

Load application (AREP or PMG excitation)

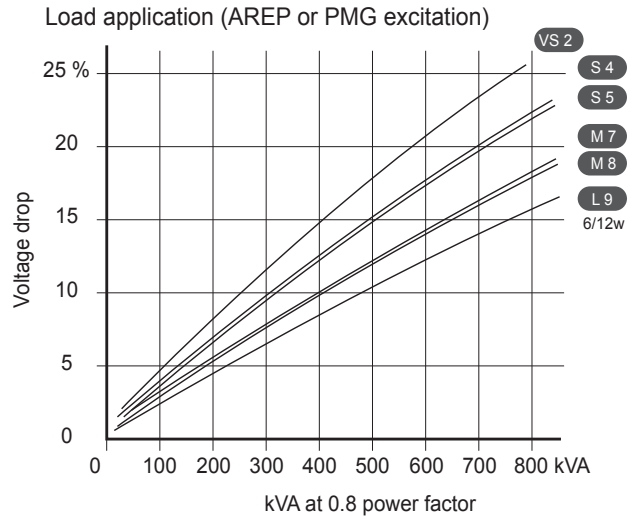

Load rejection (SHUNT excitation)

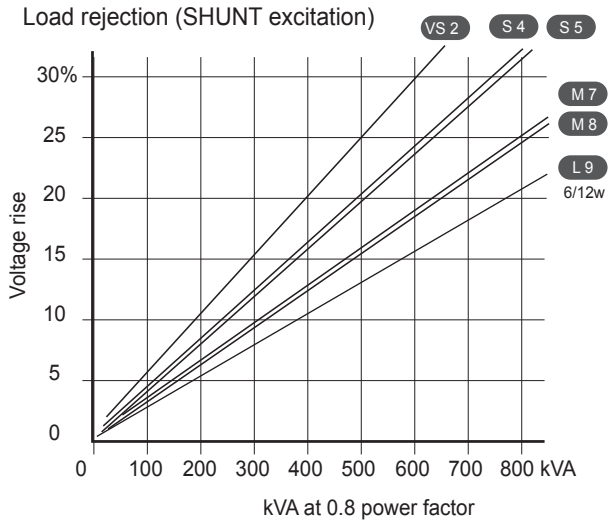

Load rejection (AREP or PMG excitation)

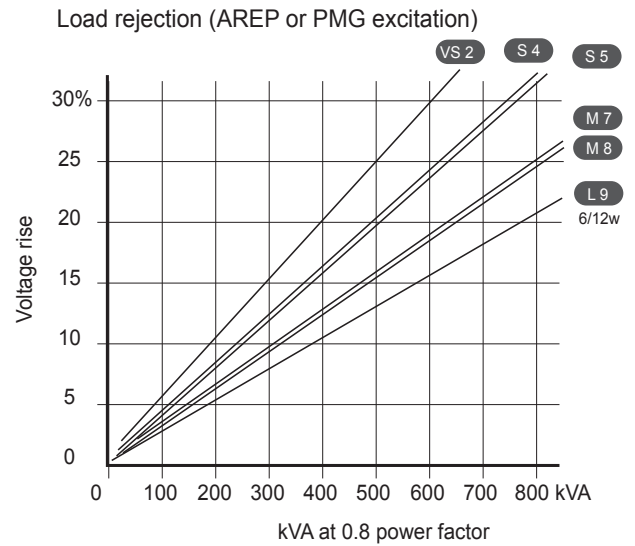

Motor starting (SHUNT excitation)

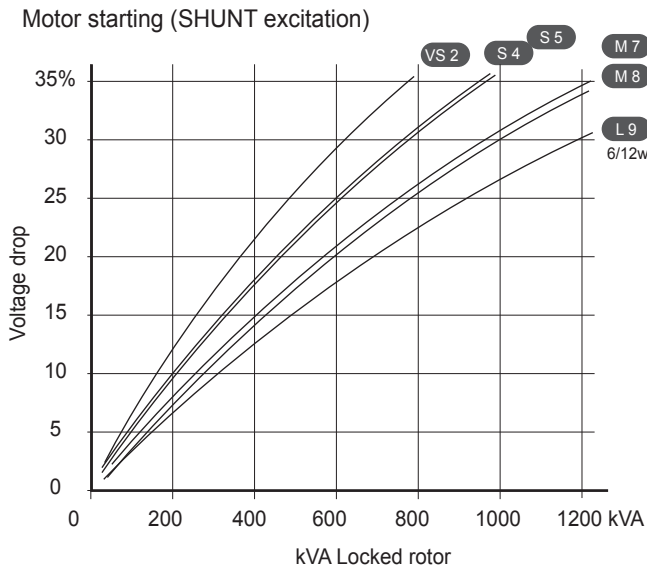

Motor starting (AREP or PMG excitation)

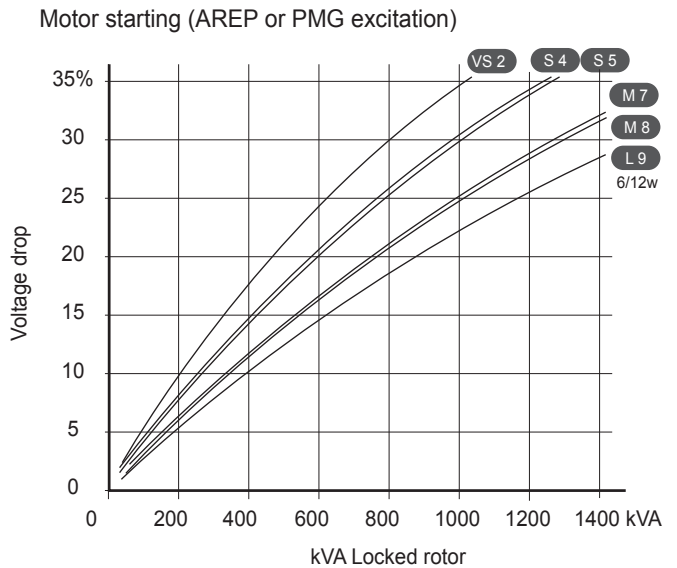

1) For a starting P.F. other than 0.6, the starting kVA must be multiplied by  $K = \text{Sine P.F.} / 0.8$

2) For voltages other than 400V (Y), 230V (Δ) at 50 Hz, then kVA must be multiplied by  $(400/U)^2$  or  $(230/U)^2$ .

# Low Voltage Alternators - 4 pole

## LSA 47.2 - 365 to 600 kVA - 50 Hz / 456 to 750 kVA - 60 Hz

### Efficiencies 480 V - 60 Hz (P.F.: 1) (P.F.: 0.8)

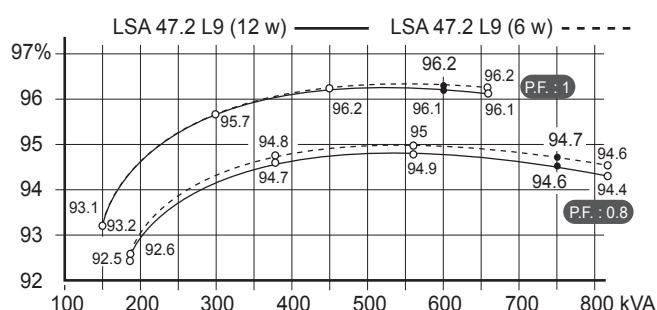
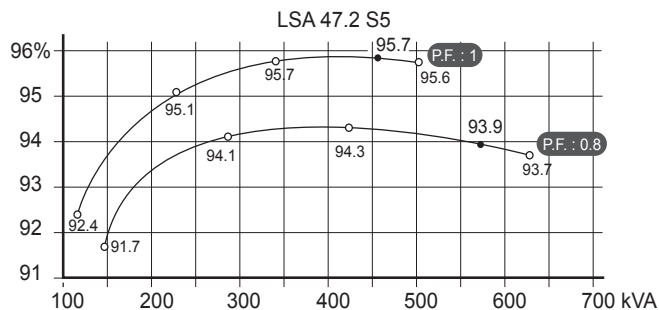
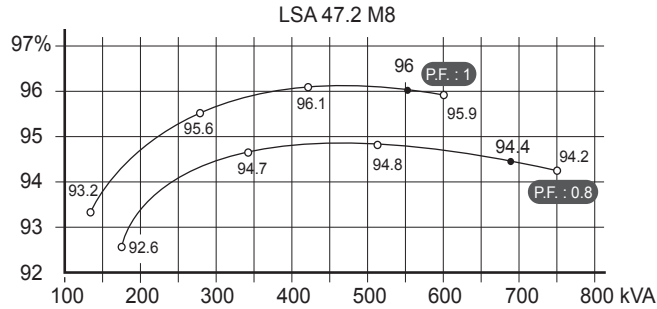
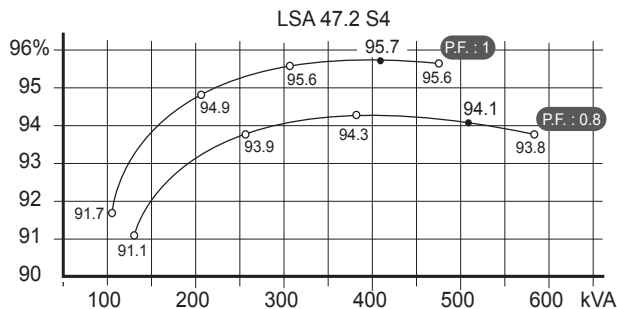
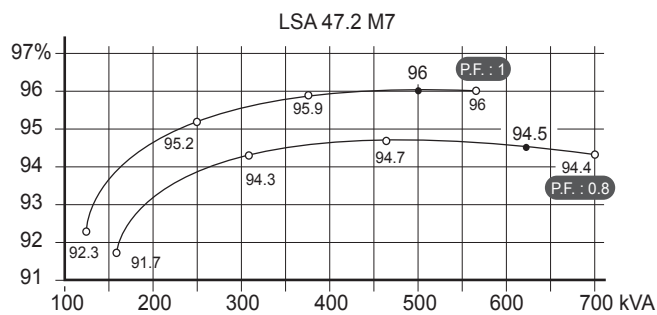
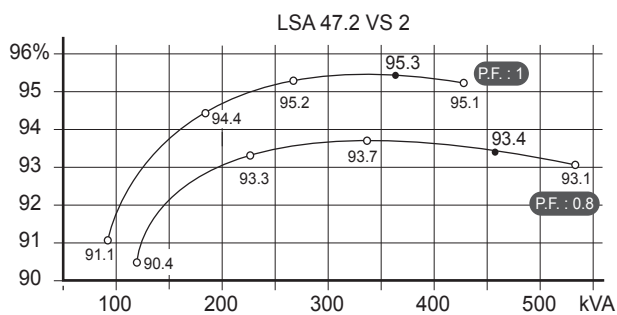

### Reactances (%). Time constants (ms) - Class H / 480 V

	VS2 (12w)	S4 (12w)	S5 (12w)	M7 (12w)	M8 (12w)	L9 (12w)	L9 (6w)
<b>Kcc</b> Short-circuit ratio	0.36	0.36	0.32	0.40	0.31	0.35	0.36
<b>Xd</b> Direct-axis synchro. reactance unsaturated	349	335	373	319	376	344	338
<b>Xq</b> Quadrature-axis synchro. reactance unsaturated	209	201	223	191	225	206	203
<b>T'do</b> No-load transient time constant	1738	1855	1855	1930	1958	1997	1997
<b>X'd</b> Direct-axis transient reactance saturated	20.1	18	20.1	16.5	19.2	17.2	16.9
<b>T'd</b> Short-circuit transient time constant	100	100	100	100	100	100	100
<b>X''d</b> Direct-axis subtransient reactance saturated	14.1	12.6	14	11.6	13.4	11.8	12.1
<b>T''d</b> Subtransient time constant	10	10	10	10	10	10	10
<b>X''q</b> Quadrature-axis subtransient reactance saturated	19.1	16.9	18.8	15.3	17.8	15.6	15.8
<b>Xo</b> Zero sequence reactance unsaturated	0.1	0.4	0.1	0.1	0.9	0.9	0.4
<b>X2</b> Negative sequence reactance saturated	16.6	14.8	16.5	13.5	15.6	13.7	14
<b>Ta</b> Armature time constant	15	15	15	15	15	15	15

### Other class H/480 V data

<b>io (A)</b> No-load excitation current	1	0.9	0.9	1	0.9	0.9	0.9
<b>ic (A)</b> On-load excitation current	3.9	3.5	3.9	3.7	3.8	3.7	3.7
<b>uc (V)</b> On-load excitation voltage	40	35	39	37	38	37	37
<b>ms</b> Response time ( $\Delta U = 20\%$ transient)	500	500	500	500	500	500	500
<b>kVA</b> Start ( $\Delta U = 20\%$ cont. or 50% trans.) SHUNT	890	1136	1136	1318	1433	1550	1554
<b>kVA</b> Start ( $\Delta U = 20\%$ cont. or 50% trans.) AREP	994	1271	1271	1473	1606	1733	1737
<b>%</b> Transient $\Delta U$ (on-load 4/4) SHUNT - P.F.: 0.8 <sub>LAG</sub>	17.3	16	17.3	15	16.7	15.5	15.3
<b>%</b> Transient $\Delta U$ (on-load 4/4) AREP - P.F.: 0.8 <sub>LAG</sub>	14.1	13	14.1	12.2	13.6	12.6	12.4
<b>W</b> No-load losses	8540	8910	8910	10080	9530	10440	10580
<b>W</b> Heat dissipation	25650	25650	29340	28630	32190	33870	33010

# Low Voltage Alternators - 4 pole

LSA 47.2 - 365 to 600 kVA - 50 Hz / 456 to 750 kVA - 60 Hz

## Transient voltage variation 480V - 60 Hz

Load application (SHUNT excitation)

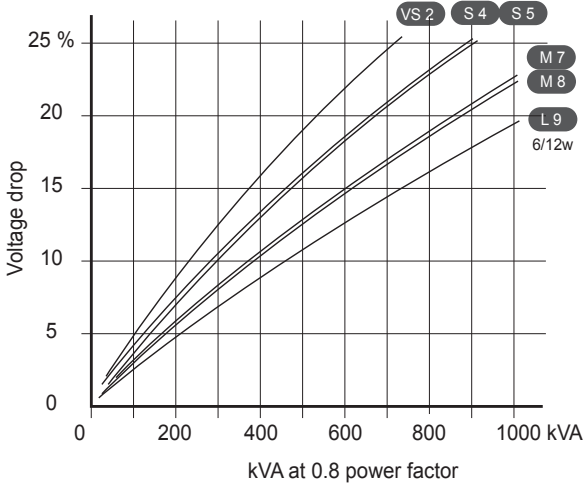

Load application (AREP or PMG excitation)

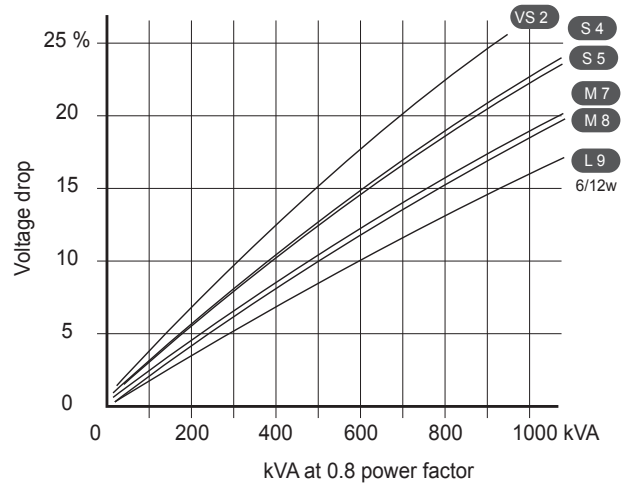

Load rejection (SHUNT excitation)

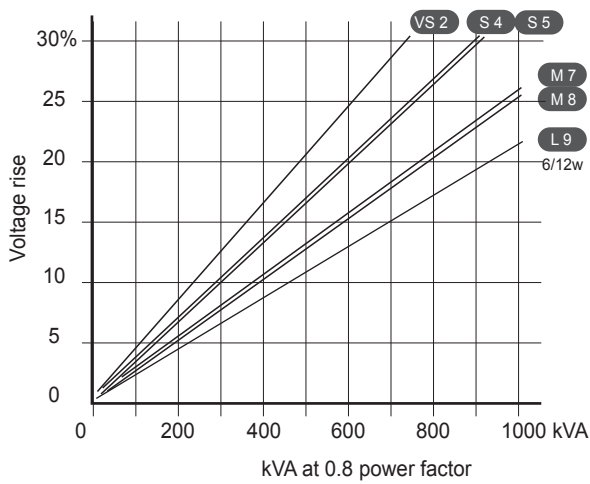

Load rejection (AREP or PMG excitation)

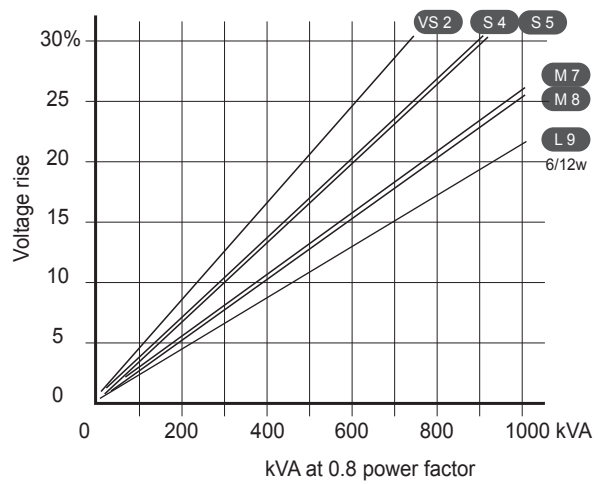

Motor starting (SHUNT excitation)

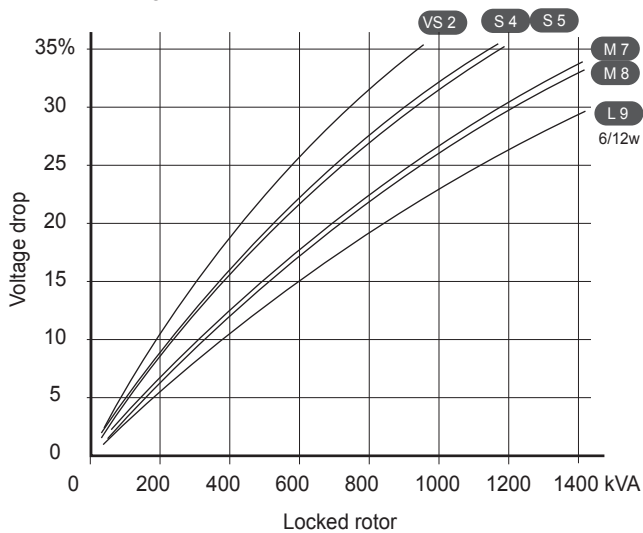

Motor starting (AREP or PMG excitation)

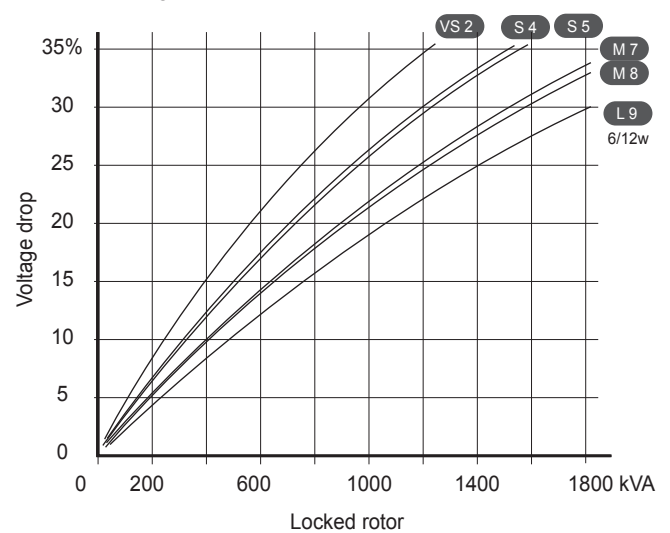

- 1) For a starting P.F. other than 0.6, the starting kVA must be multiplied by  $K = \text{Sine P.F.} / 0.6$
- 2) For voltages other than 480V (Y), 277V ( $\Delta$ ), 240V (YY) at 60 Hz, then kVA must be multiplied by  $(480/U)^2$  or  $(277/U)^2$  or  $(240/U)^2$ .

# Low Voltage Alternators - 4 pole

LSA 47.2 - 365 to 600 kVA - 50 Hz / 456 to 750 kVA - 60 Hz

## 3-phase short-circuit curves at no load and rated speed (star connection Y)

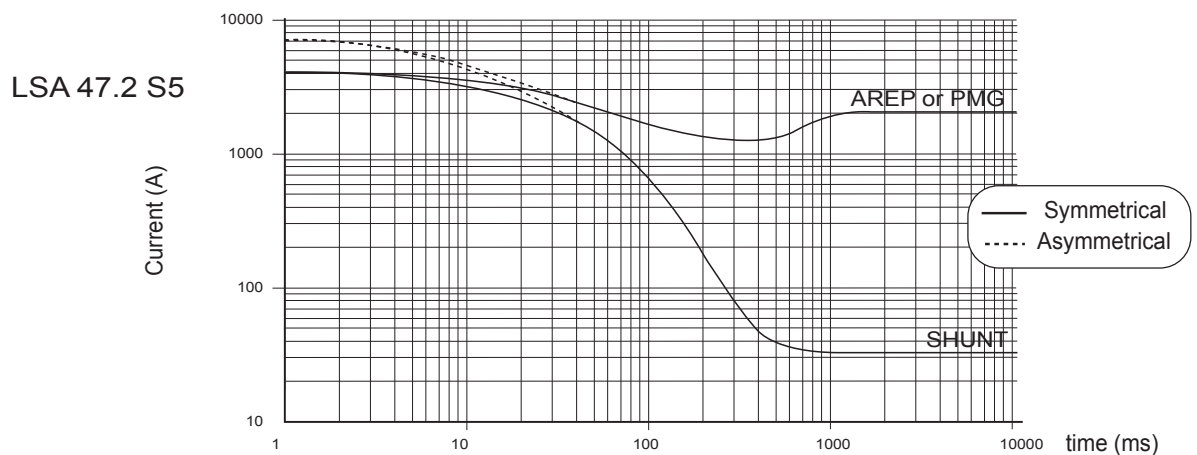
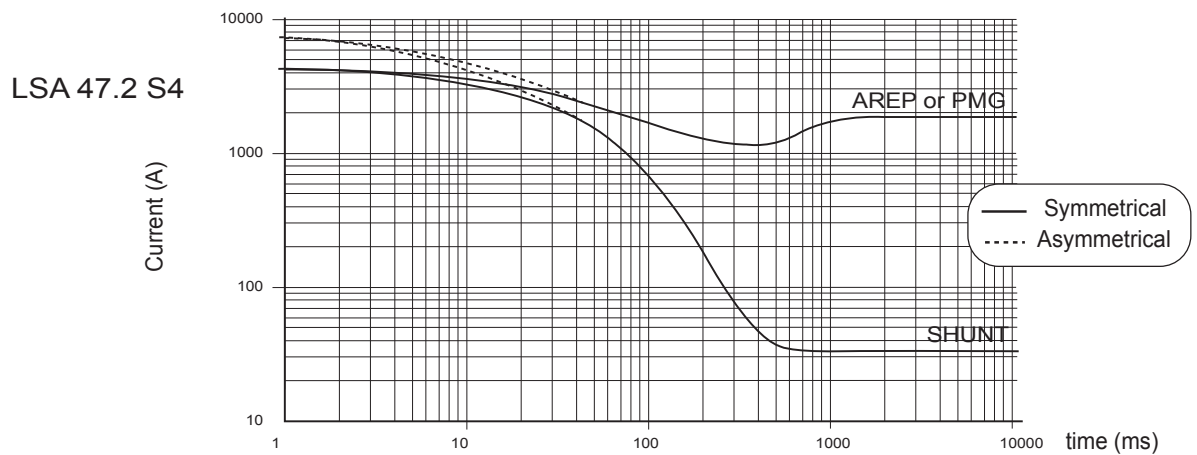
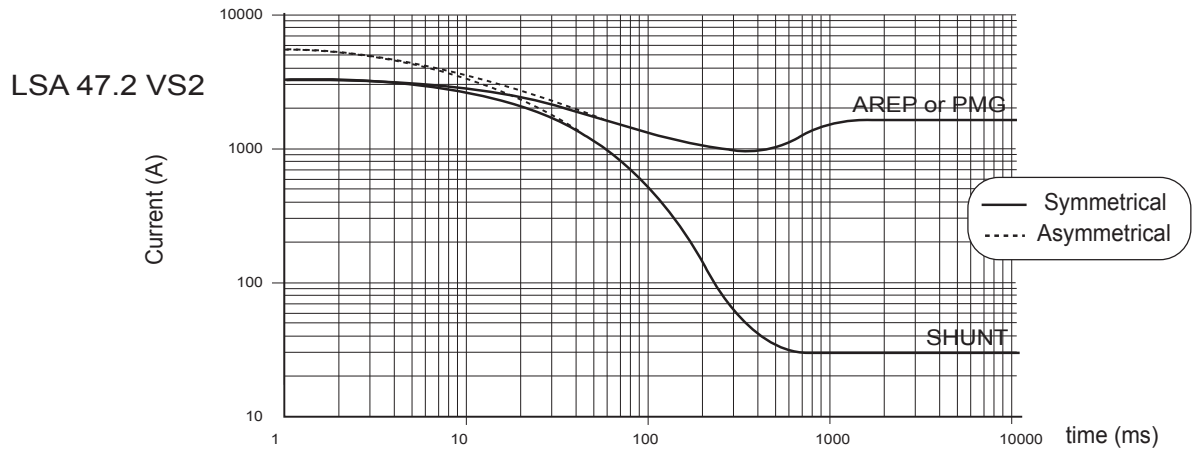

### Influence due to connection

Curves shown are for star (Y) connection.

For other connections, use the following multiplication factors:

- Series delta : current value x 1.732
- Parallel star : current value x 2



# Low Voltage Alternators - 4 pole

LSA 47.2 - 365 to 600 kVA - 50 Hz / 456 to 750 kVA - 60 Hz

## 3-phase short-circuit curves at no load and rated speed (star connection Y)

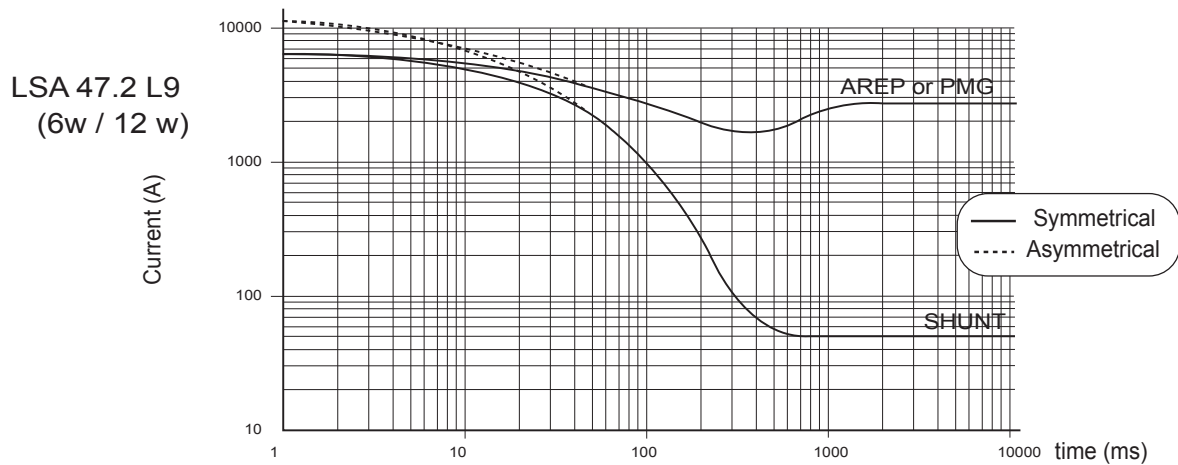
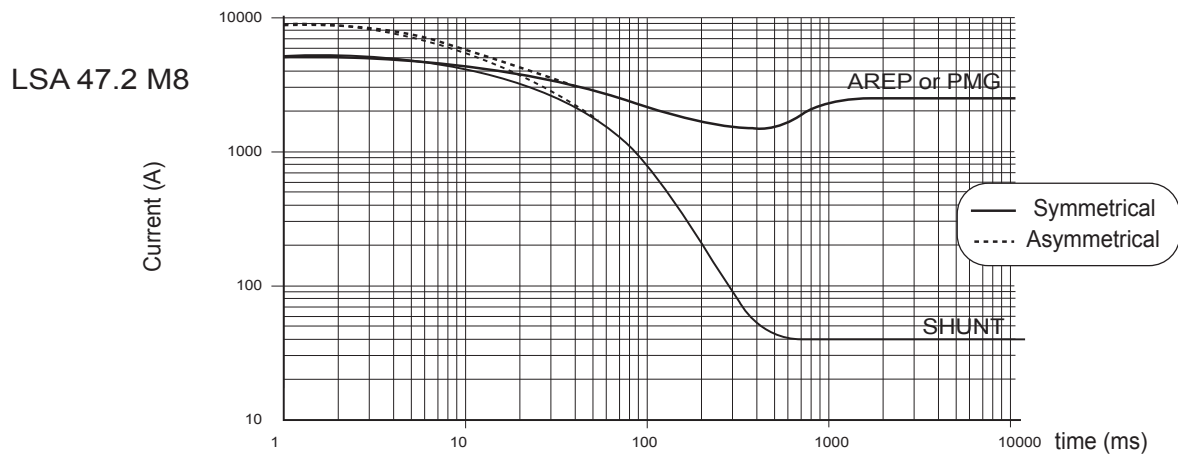
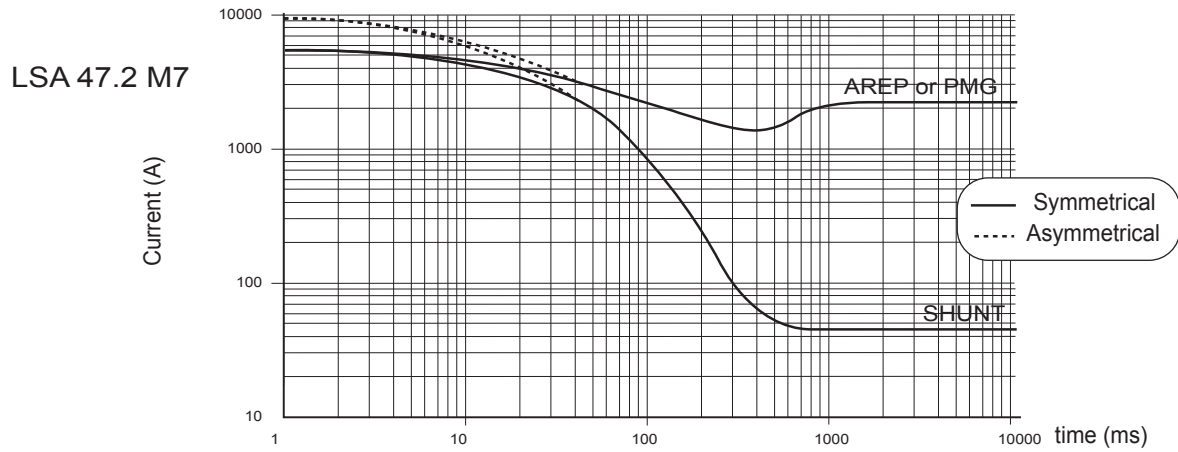

### Influence due to short-circuit

Curves are based on a three-phase short-circuit.

For other types of short-circuit, use the following multiplication factors.

	3-phase	2-phase L/L	1-phase L/N
Instantaneous (max.)	1	0.87	1.3
Continuous	1	1.5	2.2
Maximum duration (AREP/PMG)	10 sec.	5 sec.	2 sec.

# Low Voltage Alternators - 4 pole

LSA 47.2 - 365 to 600 kVA - 50 Hz / 456 to 750 kVA - 60 Hz

## Single bearing dimensions

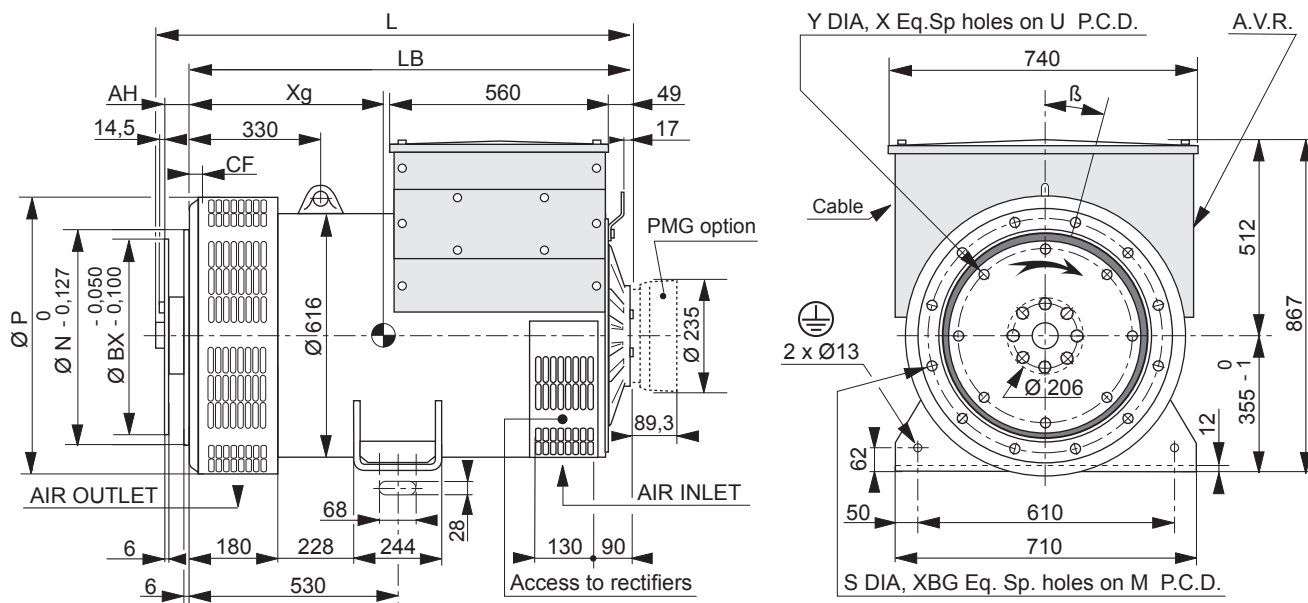

Dimensions (mm) and weight				
Type	L without PMG	LB	Xg	Weight (kg)
LSA 47.2 VS2	1041	996	437	976
LSA 47.2 S4	1101	1056	471	1113
LSA 47.2 S5	1101	1056	471	1113
LSA 47.2 M7	1201	1156	511	1240
LSA 47.2 M8	1201	1156	520	1289
LSA 47.2 L9	1221	1176	545	1372

Coupling			
Flex plate	11 1/2	14	18
Flange S.A.E 1	X	X	
Flange S.A.E 1/2		X	
Flange S.A.E 0		X	X

Flange (mm)							
S.A.E.	P	N	M	XBG	S	$\beta^\circ$	CF
1	713	511.175	530.225	12	12	15°	15
1/2	713	584.2	619.125	12	14	15°	22
0	713	647.7	679.45	16	14	11° 15'	42

Flex plate (mm)					
S.A.E.	BX	U	X	Y	AH
11 1/2	352.42	333.38	8	11	39.6
14	466.72	438.15	8	14	25.4
18	571.5	542.92	6	17	15.7

## Torsional analysis data

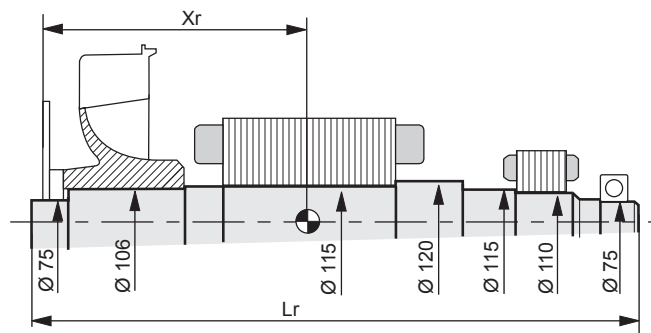

Centre of gravity: Xr (mm), Rotor length: Lr (mm), Weight: M (kg), Moment of inertia: J (kgm <sup>2</sup> ): (4J = MD <sup>2</sup> )												
Type	Flex plate S.A.E. 11 1/2				Flex plate S.A.E. 14				Flex plate S.A.E. 18			
	Xr	Lr	M	J	Xr	Lr	M	J	Xr	Lr	M	J
LSA 47.2 VS2	432.5	1029	387	5.99	418.3	1029	387	6.12	408.5	1029	387	6.38
LSA 47.2 S4	470	1089	442	6.90	456	1089	442	7.03	446	1089	442	7.29
LSA 47.2 S5	470	1089	442	6.90	456	1089	442	7.03	446	1089	442	7.29
LSA 47.2 M7	510	1189	495	7.61	496	1189	495	7.74	486	1189	495	8
LSA 47.2 M8	521	1189	514	8.01	507	1189	514	8.14	497	1189	514	8.40
LSA 47.2 L9	542	1209	547	8.52	528	1209	547	8.65	518	1209	547	8.91

**NOTE :** Dimensions are for information only and may be subject to modifications. Contractuel 2D drawings can be downloaded from the Leroy-Somer site, 3D drawing files are available upon request.

# Low Voltage Alternators - 4 pole

LSA 47.2 - 365 to 600 kVA - 50 Hz / 456 to 750 kVA - 60 Hz

## Two bearing dimensions

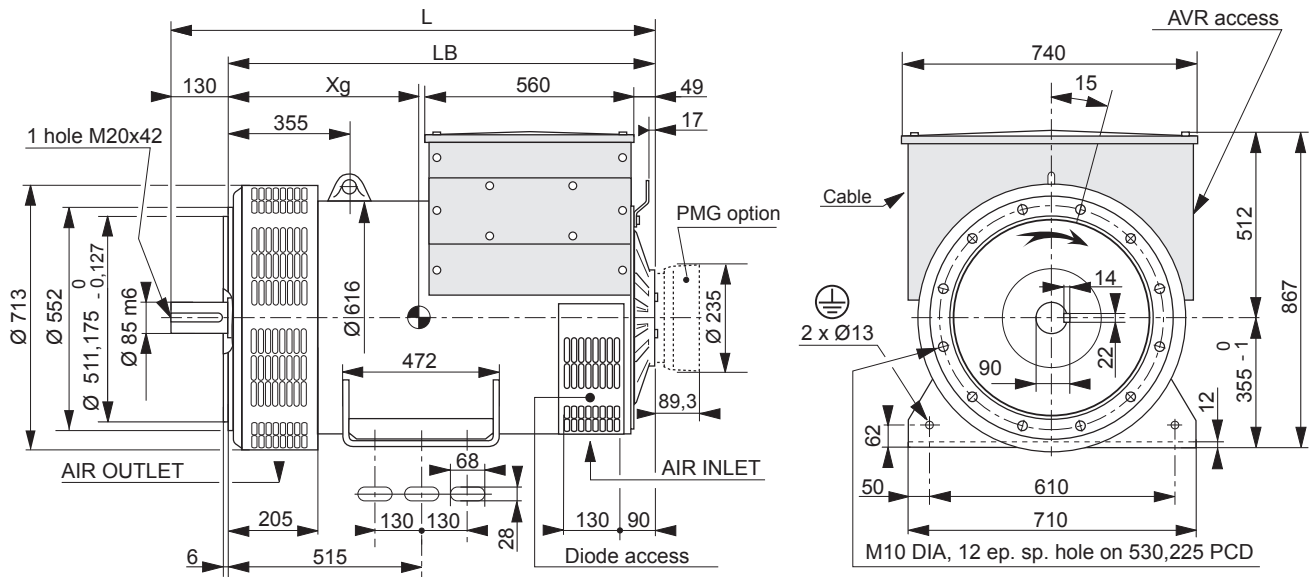

Dimensions (mm) and weight				
Type	L without PMG	LB	Xg	Weight (kg)
LSA 47.2 VS2	1151	1021	457	996
LSA 47.2 S4	1211	1081	491	1126
LSA 47.2 S5	1211	1081	491	1126
LSA 47.2 M7	1311	1181	531	1253
LSA 47.2 M8	1311	1181	531	1302
LSA 47.2 L9	1331	1201	565	1392

## Torsional analysis data

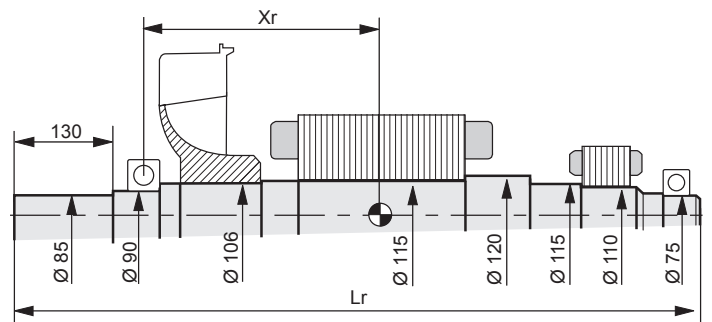

Centre of gravity: Xr (mm), Rotor length: Lr (mm), Weight: M (kg), Moment of inertia: J (kgm <sup>2</sup> ): (4J = MD <sup>2</sup> )				
Type	Xr	Lr	M	J
LSA 47.2 VS2	396.4	1139	368.5	5.79
LSA 47.2 S4	433.2	1199	424	6.70
LSA 47.2 S5	433.2	1199	424	6.70
LSA 47.2 M7	473	1299	476.2	7.41
LSA 47.2 M8	483.5	1299	494.9	7.81
LSA 47.2 L9	504.5	1319	528	8.32

**NOTE :** Dimensions are for information only and may be subject to modifications. Contractuel 2D drawings can be downloaded from the Leroy-Somer site, 3D drawing files are available upon request.

**EMERSON. CONSIDER IT SOLVED.™**

[www.emersonindustrial.com](http://www.emersonindustrial.com)

© Emerson 2014. The information contained in this brochure is for guidance only and does not form part of any contract. The accuracy cannot be guaranteed as Emerson have an ongoing process of development and reserve the right to change the specification of their products without notice.

Moteurs Leroy-Somer SAS. Headquarters: Bd Marcellin Leroy, CS 10015, 16915 Angoulême Cedex 9, France. Share Capital: 65 800 512 €, RCS Angoulême 338 567 258.

**Leroy-Somer™**

  
**EMERSON™**  
Industrial Automation